

DETAIL Praxis

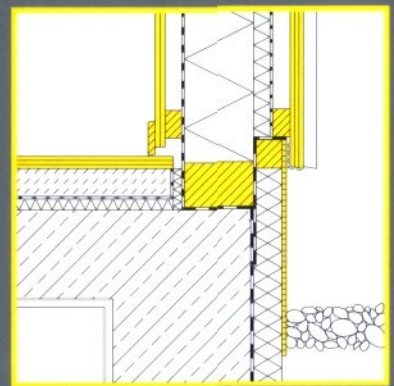

# Timber Construction

Details  
Products  
Case studies

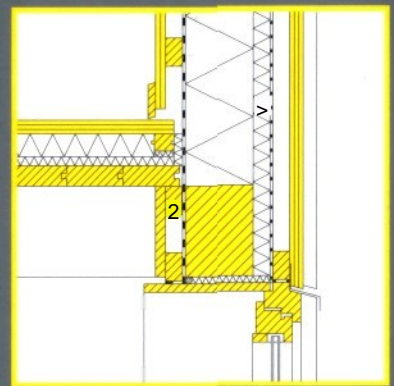
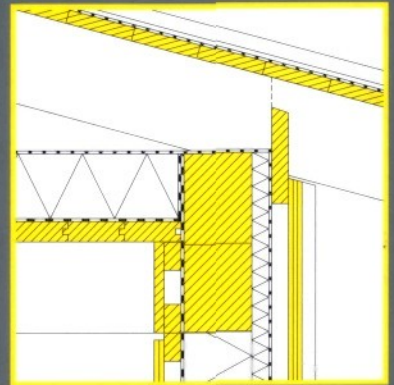

DETAILPraxis  
Timber Construction

Authors:

Theodor Hugues, Umv.-Prof. Dr. -ing., architect,  
Faculty of Building Construction and Materials at  
the Technical University of Munich  
Ludwig Steiger, Dipl.-Ing. Univ., architect,  
the Technical University of Munich  
Johann Weber, Dipl.-Ing. (FH),  
the Technical University of Munich

Theodor Hugues  
Ludwig Steiger  
Johann Weber

Drawings:

Michaela Jurck, Dipl.-Ing. Univ.

Secretary's Office:

Marga Cervinka

Editorial Department:

Friedemann Zeitler, Dipl.-Ing. Univ., architect  
Nicola Kollmann, Dipl.-Ing. (FH)

Translation German/English:

Robin Benson (pp. 1-50, 97-110),  
Adam Blauhut (pp. 51-53),  
Elizabeth Schwaiger (pp. 54-65),  
David Berry (pp. 66-78)  
Detail (pp. 80-96)

DTP 8 Production:

Peter Gensmantel, Cornelia Kohn, Andrea Linke,  
Roswitha Siegler

© 2004 Institut für internationale

Architektur-Dokumentation GmbH & Co.KG,  
P.O.Box 33 06 60. D-80066 Munich, Germany

ISBN 3-7643-7032-7

Printed on acid-free paper, manufactured from  
chlorine-free bleached cellulose.

Printed by:

Wesel-Kommunikation  
Baden-Baden

A CIP catalogue record for this book is available  
from the Library of Congress, Washington, D.C.,  
USA

Bibliographic information published by Die  
Deutsche Bibliothek

Die Deutsche Bibliothek lists this publication in  
the Deutsche Nationalbibliografie; detailed  
bibliographic data is available on the internet at  
<http://dnb.ddb.de>

This work is subject to copyright. All rights are  
reserved, whether the whole or part of the material  
is concerned, specifically the right of translation,  
reprinting, re-use of illustrations, recitation, broad-  
casting, reproduction on microfilms or in other  
ways, and storage in databases. For any kind of  
use, permission of the copyright owner must be  
obtained.

Institut für Internationale  
Architektur-Dokumentation GmbH & Co.KG  
Sonnenstrasse 17, D-80331 Munich  
Tel. +49 89 38 16 20-0  
Fax +49 89 39 86 70  
e-mail: [vertneb@detail.de](mailto:vertneb@detail.de)  
Internet: [www.detail.de](http://www.detail.de)

Distribution Partner:  
Birkhauser - Publishers for Architecture  
P.O.Box 133. CH-4010 Basel,  
Switzerland  
Tel. +41 61 205 07 07  
Fax +41 61 205 07 92  
e-mail: [sales@birkhauser.ch](mailto:sales@birkhauser.ch)  
<http://www.birkhauser.ch>

in co-operation with the  
Verbande des Bayerischen Zimmerer- und  
Holzbaugewerbes. Munich

Contents

9	Introduction
11	House A
12	Exterior wall, plinth
13	Interior wall, floor above basement
14	Exterior wall, floor/ceiling, window
15	Interior wall, floor/ceiling, door
16	Exterior wall, ceiling, eaves
17	Exterior wall, ceiling, verge
18	Exterior wall, services installation shaft
19	Party wall
21	House B
22	Exterior wall, plinth
23	Interior wall, sole plate
24	Exterior wall, foundation
25	Interior wall, foundation
26	Exterior wall, floor/ceiling, window
27	Interior wall, floor/ceiling, door
28	Exterior wall, eaves
29	Exterior wall, verge
30	Exterior wall, corner
31	Party wall
33	Product overview
34	Timber
40	Manufactured Wood Products
50	Building boards
53	Insulating materials
66	Sheathing paper
70	Joints and fasteners
76	Wood preservation
78	Joint sealing tapes
80	Overview of exemplary constructions
81	Exemplary constructions
97	Technical information
100	Standards
101	Literature
102	References
107	Subject index
109	Index of projects
110	Picture credits

The *Arbeitsheft Holzbau*, the precursor of this book, arose at the suggestion of the Bayerisches Zimmerer- und Holzbaugewerbe and was sponsored by the Stiftung des Bayerischen Zimmerer- und Holzbaugewerbes Donat Miiller.

The authors should like to extend their special thanks to Univ.-Prof. Dr.-Ing Heinrich Kreuzinger (load-bearing structure) and Dipl.-Ing. (FH) Georg Wust and Dipl.-Ing. (FH) Wolfgang Hallinger (construction and materials).

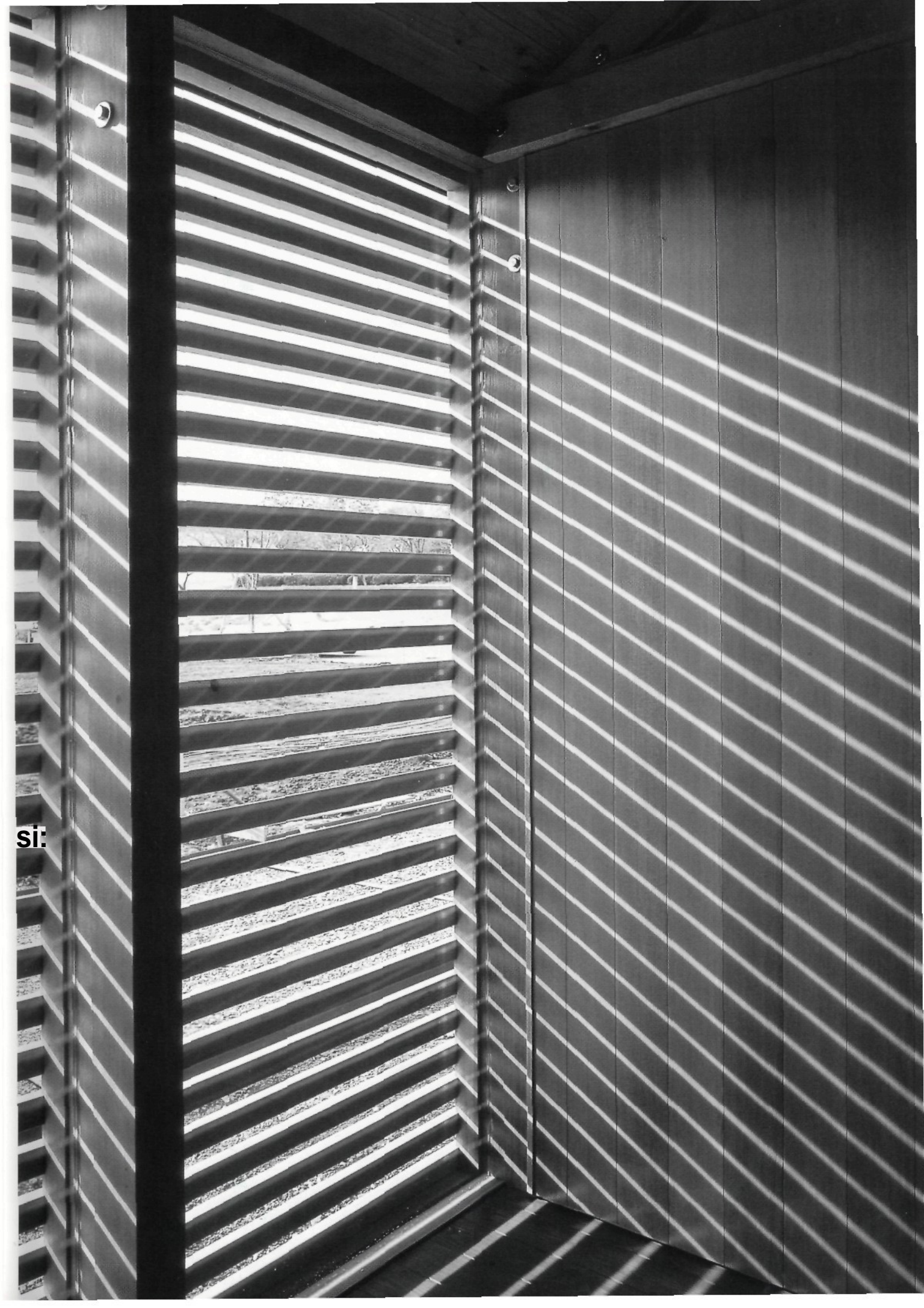

## Introduction

The *Arbeitsbeft Holzbau* is intended as an aid to all those working in the field of construction. However, it is neither a construction manual nor an encyclopaedia of materials. It aims to show the relationship between design, detail work and the built product. What has emerged is a very handy book which summarises, in a user-friendly manner, all the material found in offices and enterprises that deals with building with wood. To avoid the selection presenting here falling prey to rapid obsolescence and, above all, premature obsolescence, it has been limited to basic designs and proven materials.

### Part 1

The first part provides an overview of the exemplary use of building components, component layers and building materials and their integration into the overall structure of two prototypical limber houses of different design. Questions concerning building physics, such as heat, and sound insulation, vapour and fire protection, draught proofing and jointing are briefly explained and presented in graphic examples of details and joints typical of wooden construction. Two simple, common types of terraced house have been designed and constructed to illustrate the interconnections and the problems. Common to both types is the relatively low roof pitch permitting the use of light roofing materials. Both houses can be heated with gas.

*House A* is a craft-built timber-framework house standing on a cellar, its lattice-work walls rest on the cellar walls and the floor above the cellar and bear a wooden joist ceiling as well as a doubly supported roof structure which has not been fitted out. The distance between the post axes and the ceiling joists is 125 cm, making it a multiple of the module of 62.5 cm, which many of the building materials observe. The disadvantage of using thicker boarding on the visible joists has to be weighed up against the spatial (hall width, cubic measure) and the design advantages (door and window openings without trimming). It could be reduced to 83.33 cm (250 cm: 3).

To improve the dimensions of the roof overhang at the eaves and the verge, the rafter spacing between was halved to 62.5 cm.

The greater part of *House B* is designed to be produced in the workshop and assembled from prefabricated wall elements, floors and a roof on a floating foundation, assuming that the subsoil is suitable. The roof has been fitted out and integrated into the interior.

The design is based on a dimensional co-ordination of 62.5 cm, corresponding to the basic elements of panel construction such as the panel dimensions of the plywood, chipboard and, above all, plasterboard / gypsum-fibre board. This dimensional co-ordination has proven to be a useful standard for partial and full prefabrication.

The development of the skin and its material implementation has been executed in accordance with the different goals of the two projects.

### Part 2

The generic terms of building materials and joints and fasteners have been italicised in the commentary on the details. In part 2 they are listed in the subject index under the marked generic term along with products, specifications and manufacturers.

### Part 3

The brief illustrated documentation of the nine completed projects is intended to convey an impression of the diverse types of wooden buildings, showing the designs chosen, the specific ways in which the details have been elaborated, and the materials used.

### Part 4

The appendix contains technical information, a summary of the pertinent guidelines and standards together with a bibliography and a list of manufacturers, also includes cross-references that allow readers to follow the path from the manufacturer to the product and its use and vice versa, as well as a subject index and list of names,

House A

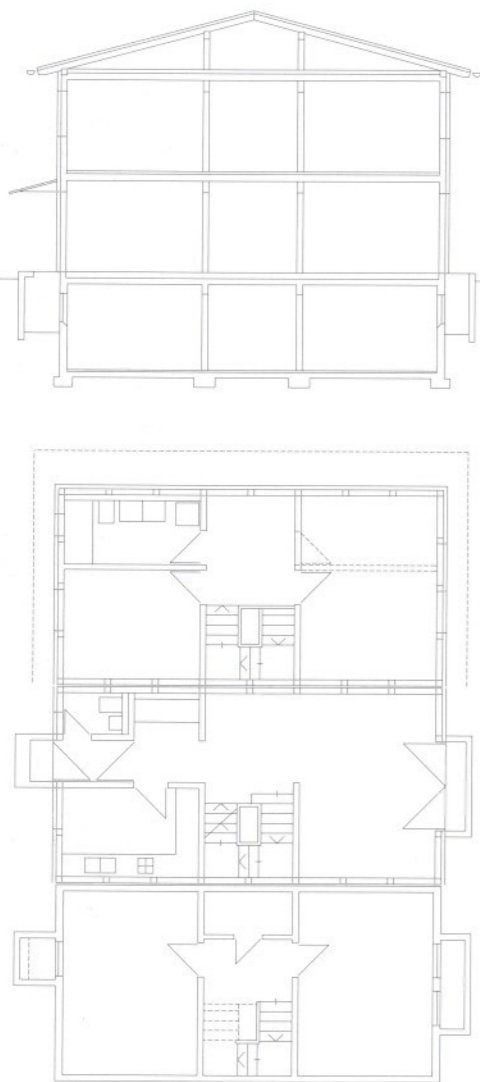

House B

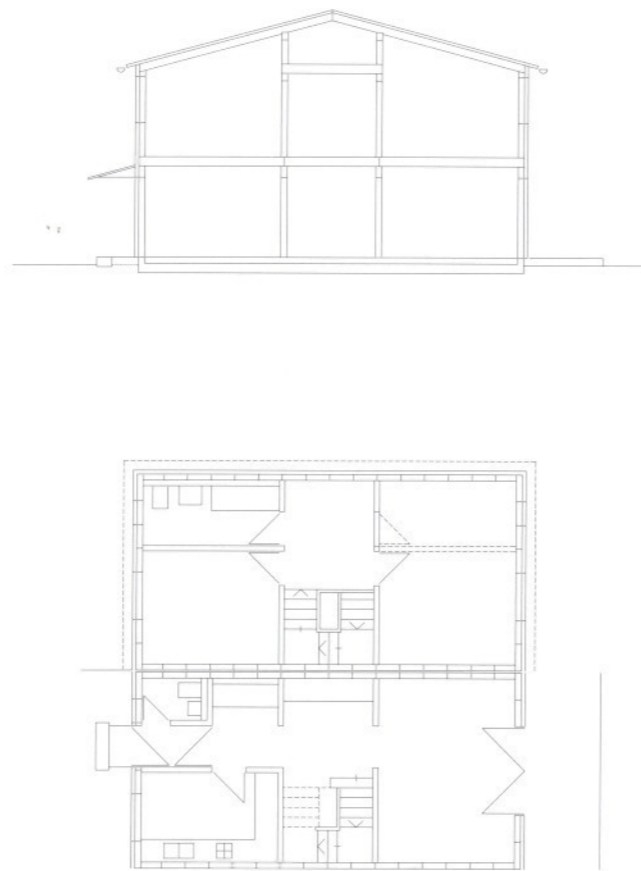

House A

- 12 Exterior wall, plinth
- 13 Interior wall, floor above basement
- 14 Exterior wall, floor/ceiling, window
- 15 Interior wall, floor/ceiling, door
- 16 Exterior wall, ceiling, eaves
- 17 Exterior wall, ceiling, verge
- 18 Exterior wall, services installation shaft
- 19 Party wall

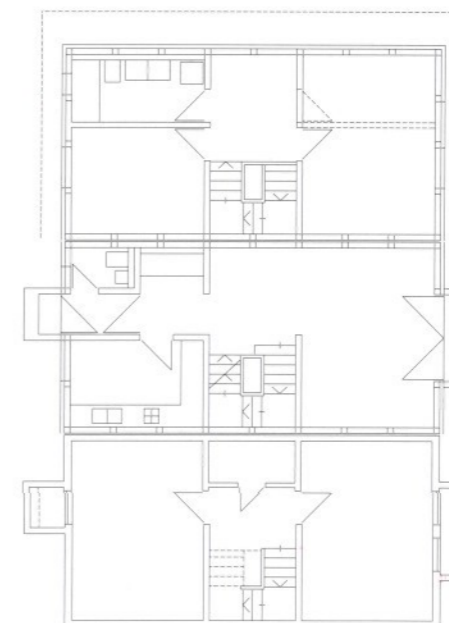
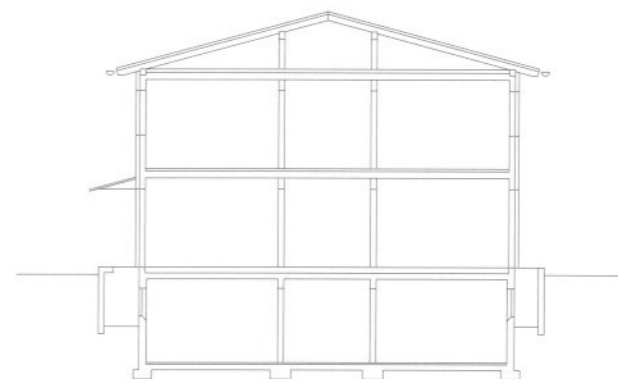

All of the detail drawings are drawn to a scale of 1:10.  
 The yellow squares refer to specific texts.  
 The diverse building components have been developed as variations and represent exemplary solutions that must be adapted to specific marginal conditions, prevailing legislation, standards and manufacturers' recommendations. The authors shall not be liable for any claims made against them on the basis of the material presented here.

□ a

Under DIN 18195, and to ensure that the wood is protected, a plinth height of 30 cm must be observed. Although a plinth can be lower in principle, special measures must be taken where this is the case, for example: a roof overhang, offsets, weather-protected sides, and coarse gravel strips to reduce water splashing.

The *perimeter insulation* of the exterior basement wall is covered on the outside for aesthetic reasons and to offer protection against any mechanical damage, for instance, with a fibre-cement slab.

Lib

The *perimeter insulation* and the wall structure must be made to harmonise with one another at the transition of the *perimeter insulation* to the facade. The cross-section for the *ventilation* must not be obstructed in any way. If banked-up coarse gravel is used to push the lower panel edge against the *insulating board*, the *fibre-cement slab* need only be fastened with a batten along its upper edge. The vertical panel joint must be executed in a way that prevents moisture from seeping behind the panel.

U c

The wooden sill plate must take up the tolerances of the concrete floor above the basement. The joint is sealed with high-expansion cement mortar. The *wooden sill plate* must be impregnated both to protect it and insulate it from the concrete floor. *Chemical wood preservative* is not necessary if timber species with a high *resistance class* are used. To attach the bar-reinforced sill plate to the floor, the plate is drilled through and then anchored with a heavy-duty bolt, taking care that a safe distance is maintained to the edge of the concrete.

(Alternatively, the sill plate can be fixed with an angle attached to the side or with a ragbolt cast in concrete.)

□ d

The *exterior wall* construction consists of 12 x 12 cm posts with a unit spacing of 125 cm, and a vertical or horizontal intermediate structure adapted both to the substructure of the exterior and interior lining and to the format of the *thermal insulation*. Insulation can be applied panel or roll form, or sprayed on in flake form. Flakes should only be injected if there are sealed chambers between the posts. A softboard is fixed across the entire bearing structure to reduce heat loss through the structure and the joints. The panels, to which battens can be directly fixed, are rebated to provide *draught-proofing*.

If a fibrous insulating material is used, vertical battening and some kind of draughtproofing will be necessary.

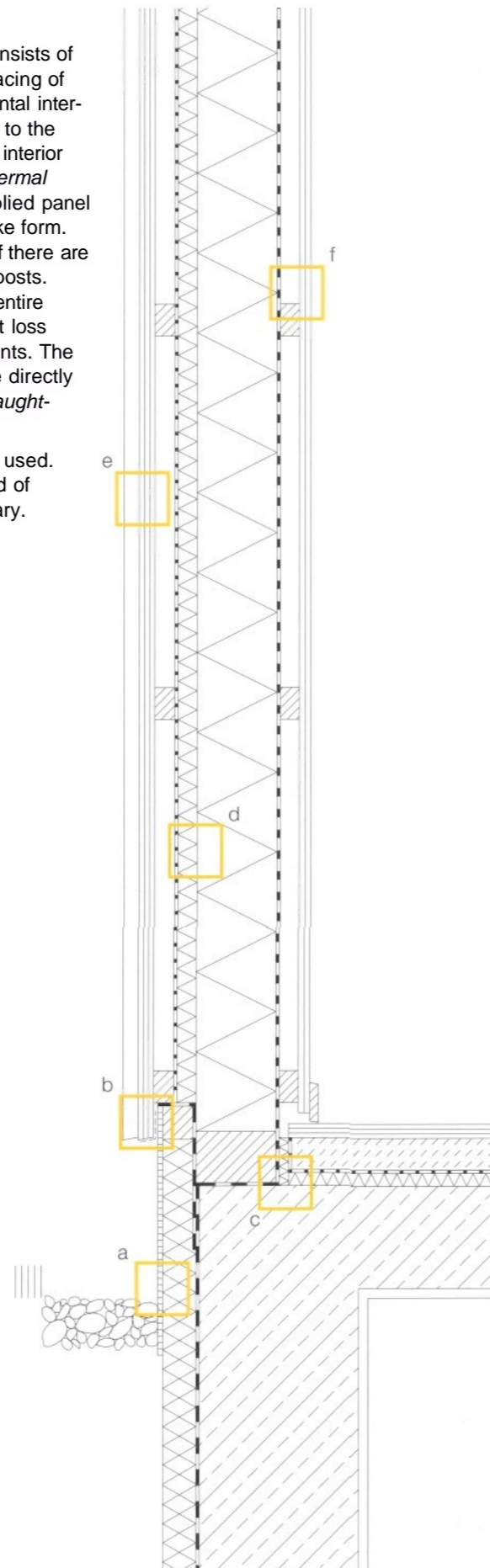

□ e

The ventilation cross-section between the weatherboarding and the inner board is sufficient to ensure *ventilation* of the exterior skin.

If more resistant and well-patinated wood species such as larch, cedar and Douglas fir are used, the surface *boarding* need not be treated. However, this will not prevent the wood from greying, which is harmless in any case. If other woods are used, a weather-protective layer, such as a glaze or a coat of paint, will be necessary - depending on the resistance class.

□ f

The interior lining comprises vertical matchboards attached to a horizontal batten substructure. If the post spacing is 125 cm, the substructure should have a cross-section of at least 30 x 50 mm or - better still - 40x60 mm.

In this area, dimensional tolerances can be compensated for and electrical cables laid. However, there is too little space to fit electric sockets here without piercing the *vapour retarding layer* inside the thermal insulation. As it is difficult to mount connections on the *vapour retarding layer*, electric sockets and switches should be installed on the Interior walls whenever possible.

● g

The load-bearing interior walls also consist of 12 x 12-cm post with horizontal rails. The *sill plate* must be anchored in the same way as the exterior wall to the floor above the basement. It is not necessary to observe minimum distances (the *stairwell* being an exception) between the heavy-duty bolt and the concrete edge here.

When constructing the floor, care must be taken that the *sill plate* is high enough to ensure that the floating screed terminates at an edge insulating strip. Although flush skirting boards offer a more elegant solution, they are also more expensive.

Dh

The electrical installations are routed through the cavity in the interior wall, which is soundproofed with a *mineral-* or *coconut-fibre* panel. If stable load-bearing structures are used (for example, solid structural timber with additional horizontal rails), the *boarding* can be mounted directly. Alternatively, plywood or *OSB panelling* can be used.

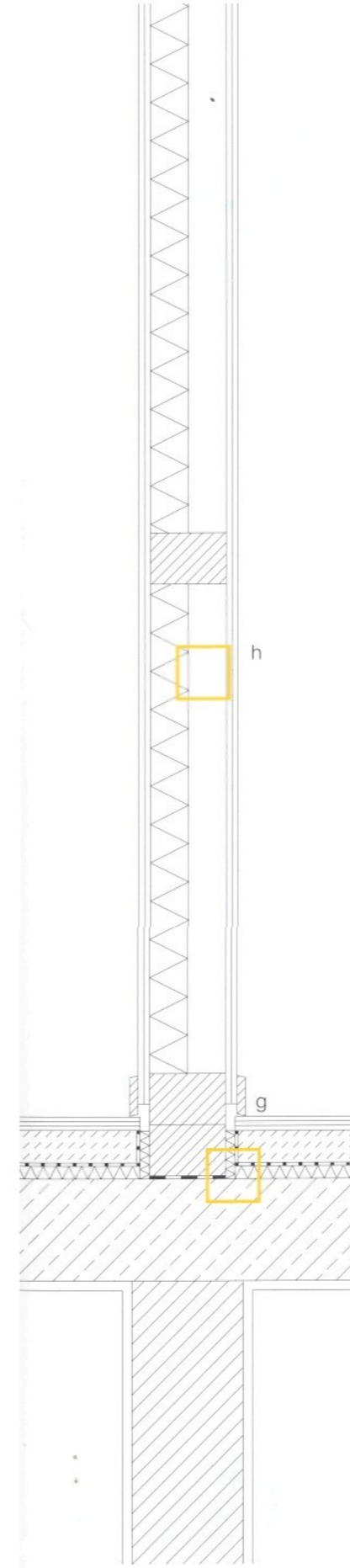

a

The window, which is mounted flush with the wall and fixed to the rail at sill level with a metal angle, provides a simple transition to the overlapping vertical *weatherboards*. Care must be taken that the angle is mounted on the bearing structure in front of the soft particleboard. The *draughtproofing* can be fixed to a batten beneath the outer window frame.

A similar procedure is adopted on the inside when connecting the *vapour retarding layer* to the prefabricated window frame, which is fixed to the outer frame. Before the *vapour retarding layer* is mounted, the joint between the window frame and the bearing structure must be carefully filled out or foam-filled with insulating material.

*Joint sealing tape* must also be applied to ensure that the window is airtight. In January 2002, the Ordinance on Energy Saving came into effect, which tightened up the requirements for *exterior walls*. Under the ordinance, these walls must be constructed and verified as totally draught-proof enclosures. This applies, in fact, to all junctions, especially for those at the window surrounds.

b

The exposed transverse joists in the floors are fixed to the posts with galvanised steel sheet *Joist hangers*. To ensure that vapour is fully retarded, a section of foil - to which the *vapour retarding layer* is subsequently attached - is attached to the bearing structure when the beam is fixed. A board is fitted between the beams to a batten substructure to create a flush connection to the interior wall cladding and cover the underside of the joint between the panelling and the bearing structure. This step is necessary as swelling may cause movement in the panelling.

To prevent airborne noise entering at the edge of the ceiling, the joint between the floor and the wall must be carefully filled in with insulating material.

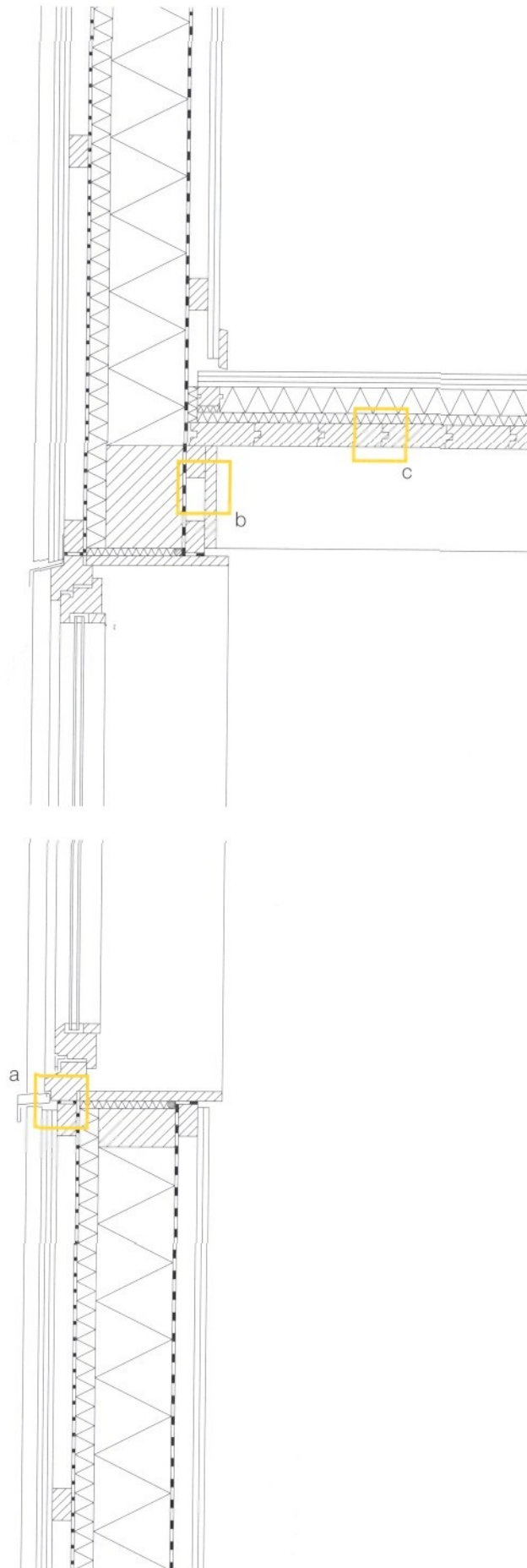

c

As a structural grid of 125 cm has been chosen for the building, tongued-and-grooved floor covering is required. A floor comprising plain floorboards on timber bearing strips laid loose and filled with insulating material will suffice for a detached house. If prefabricated parquet or sheet flooring is preferred, it is advisable to lay the flooring on a load-bearing surface of ready mixed *dry screed*. Airborne-sound insulation can be optimised by putting loose fill beneath the impact-sound insulation or by ballasting the floor structure with, for example, paving flags attached with adhesive to give a shear-resistant bond.

d

The joint between the lintel beam and the doorframe is filled in with insulating material to improve the *sound insulation* of the interior wall. The rebate in the solid door frame not only seals the joint with the interior-wall lining, but also creates a harmonious transition between the door and window flashing on the one hand, and the interior boarding on the other.

De

The floor joists rest on the head of the interior load-bearing wall. The space between the joists is sealed with an additional rail at the same level as the joists. This area can now be covered with a board, as was the case with the *exterior wall*.

f

The solid door frame is connected to the floor by a *threshold*, a measure which not only ensures greater stability when transporting the door frame, but also makes it possible to lay the flooring without having to fit it into the door reveal.

To provide adequate *impact-sound insulation* here too, an insulating strip is fitted between the *threshold* and the flooring. The joint between the *threshold* and the planks is filled with a cork strip to absorb any movements in the materials.

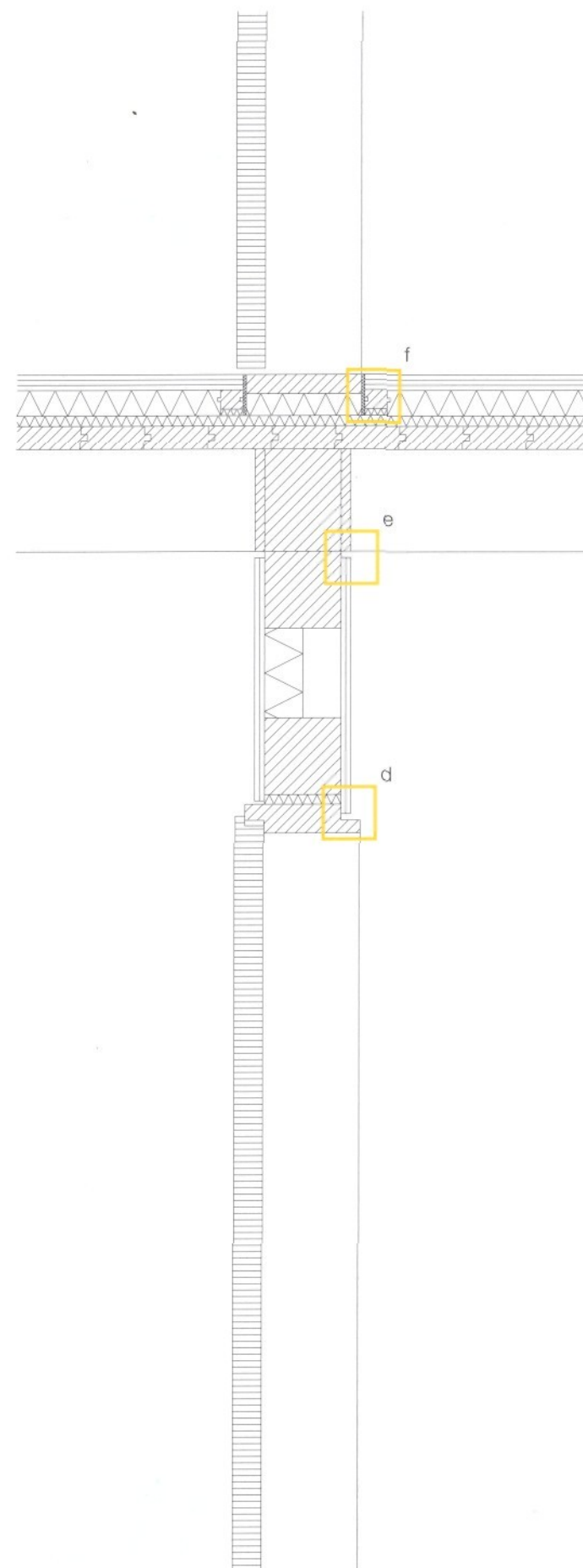

● a

A sheet-metal covering joined with locked double-welt standing seams and laid on a *separation layer* has been chosen for the roof covering. If the *separation layer* is to serve as sheathing, a more resistant material, appropriately laid, should be used. The rafter spacing of 62.5 cm corresponds to the support-grid of 125 cm. Instead of planed boarding, a panel of watertight adhesive bonded *plywood* has been used, which allows the roof-skin overhang to be extended over the ends of the rafters at the eaves. A *chemical wood preservative*, as required under DIM 68 800, is unnecessary. As the overhang is to be fixed to the rafters, its size must be adapted to the length of the gutter bracket. The panel widths are obtained by dividing a standard panel in equal parts to avoid waste, for example by quartering a 125 cm-wide panel.

□ b

The floor beneath the roof void is designed in the same way as the upper floor, whose *joists* are connected to the posts by beams. A carpenter fits the *vapour retarding layer* and the *thermal insulation* in sections, connecting them with the ceiling boarding to the roof boarding of the profiled planks. They are then covered with a water-repellent *draughtproofing* designed to allow diffusion. The roof overhang on the gable side calls for a relatively large cross-section for the projecting eaves purlins. The *draughtproofing* is attached to the eaves purlin.

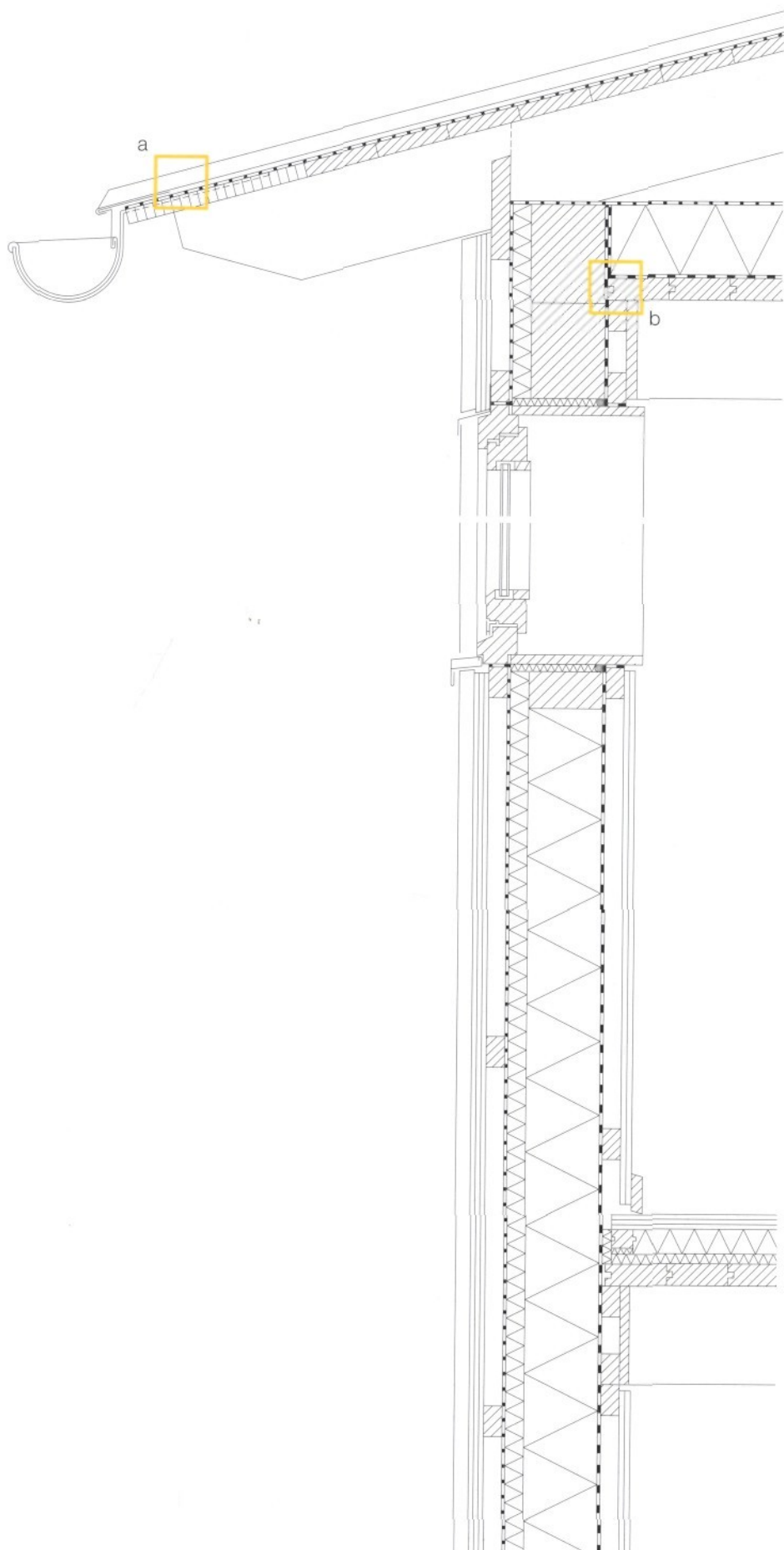

□ n<sub>c</sub>

To ensure that the roof edge is kept as narrow as possible, the seam at the verge is bent over and bonded to the overhanging roof boarding to form a drip batten. The building's low height allows for a sheet bay width of 62.5 cm and thereby harmonises the locked double-welt standing seams with the rafter arrangement, which corresponds to half the structural grid.

□ d

In the gable area, the *exterior wall* structure only extends as far as the floor beneath the roof void. The roof void is not insulated to the outside. In order to fit the insulation, the *draughtproofing* and the *vapour retarding layer* at the transition from the wall to the ceiling, an edge beam has been fitted to the roof boarding so that the individual insulating layers can be attached to both its long sides.

□ e

The vertical exterior boarding extends as far as the lower edge of the roof boarding; it is screwed to a plank running along the edge rafter on the lower side of the roof boarding. At this edge, air from both the ventilated roof and the wall construction can escape through the ventilation cross-section of the overlapping vertical *weatherboarding*.

□ f

A vertical plank, fixed to the side of the posts, will provide sufficient support for the load-bearing roof boarding at the gable wall.

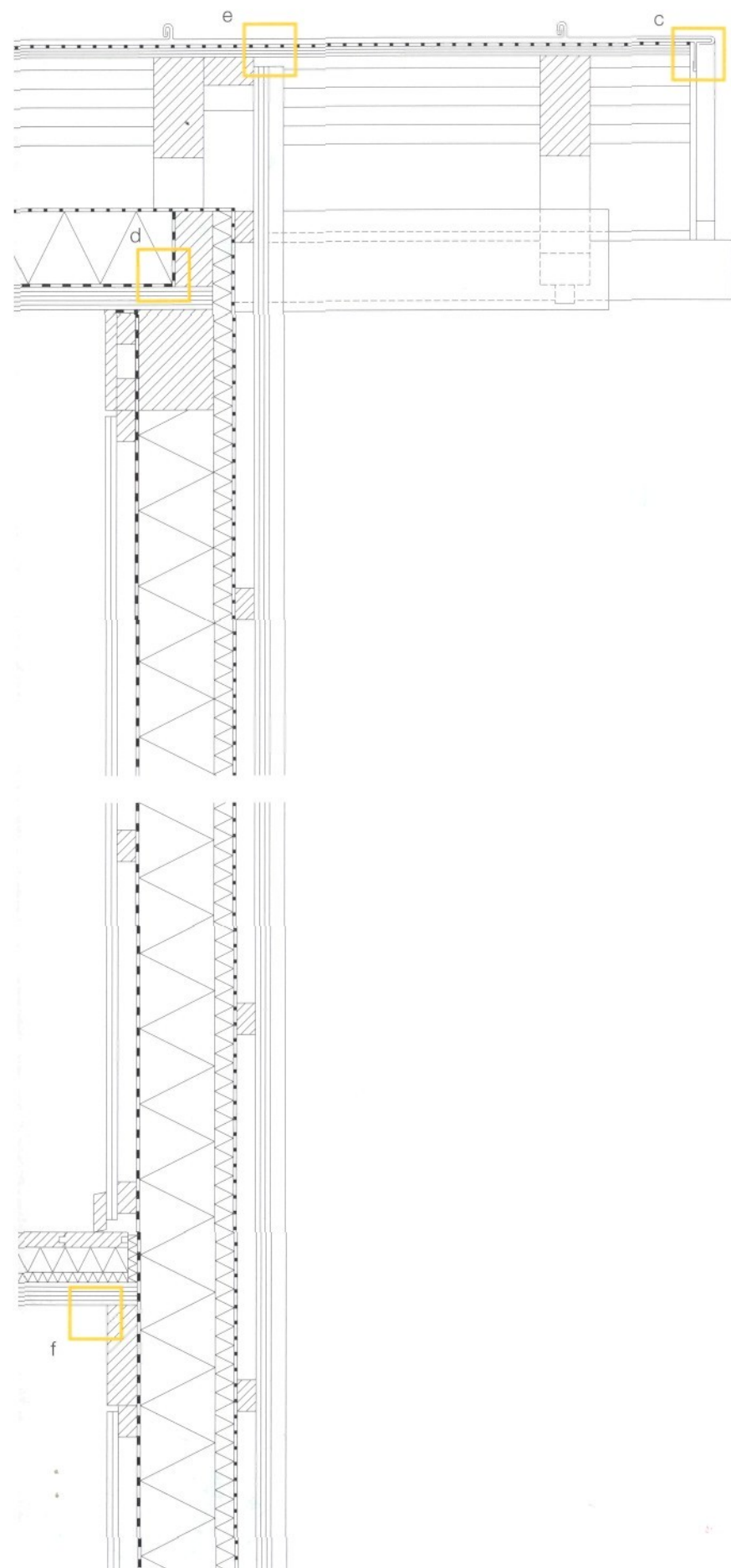



a

The exterior corner of the overlapping vertical *weatherboarding* is easily made by connecting the window boards to create a butt joint. The boards are fixed to the horizontal battens with *nails* or screws of stainless steel (they may be galvanised only in exceptional cases! to avoid corrosion stains on the boarding, Each board is fixed separately to avoid tension due to swelling and shrinkage.

The joint can be made *airtight* by overlapping or bonding the boards at the corner.

b

Normally, boards of equal width are used for the overlapping vertical *weatherboarding*. As the outer boards overlap those beneath them - approx. 25 mm on each side - the boards appear to be of different widths. This system allows for differences in spacing between the boards, obviating the need to use door and window flashings of special widths. It is essential that the facade be planned carefully and all measurements be precisely attuned to the positioning of the boards.

When windows are installed flush, they must be attached to the side of the outer frame in such a way that the overlapping *weatherboard* seals the joint between the outer frame and the wall. There is no need for the casement to be rebated at the side. The *draughtproofing*, insulation and the *vapour retarding layer* are connected to the wall structure in precisely the same way as the window to the lintel and the parapet beam.

c

For the services shaft, a substructure comprising 6 x 20 or 8 x 20 cm posts is necessary. Optimally, it is constructed half a grid space in the *exterior wall* to reduce the span of the *planking*. Ceramic tiles are bonded to the *gypsum fibreboard* or impregnated *plasterboard* (identification colour: green).

When connecting the sanitary fittings, the location and dimensions of the posts and rails must be taken into consideration, [f the rib spacing exceeds 40 cm, two layers of *plasterboard* will be necessary.

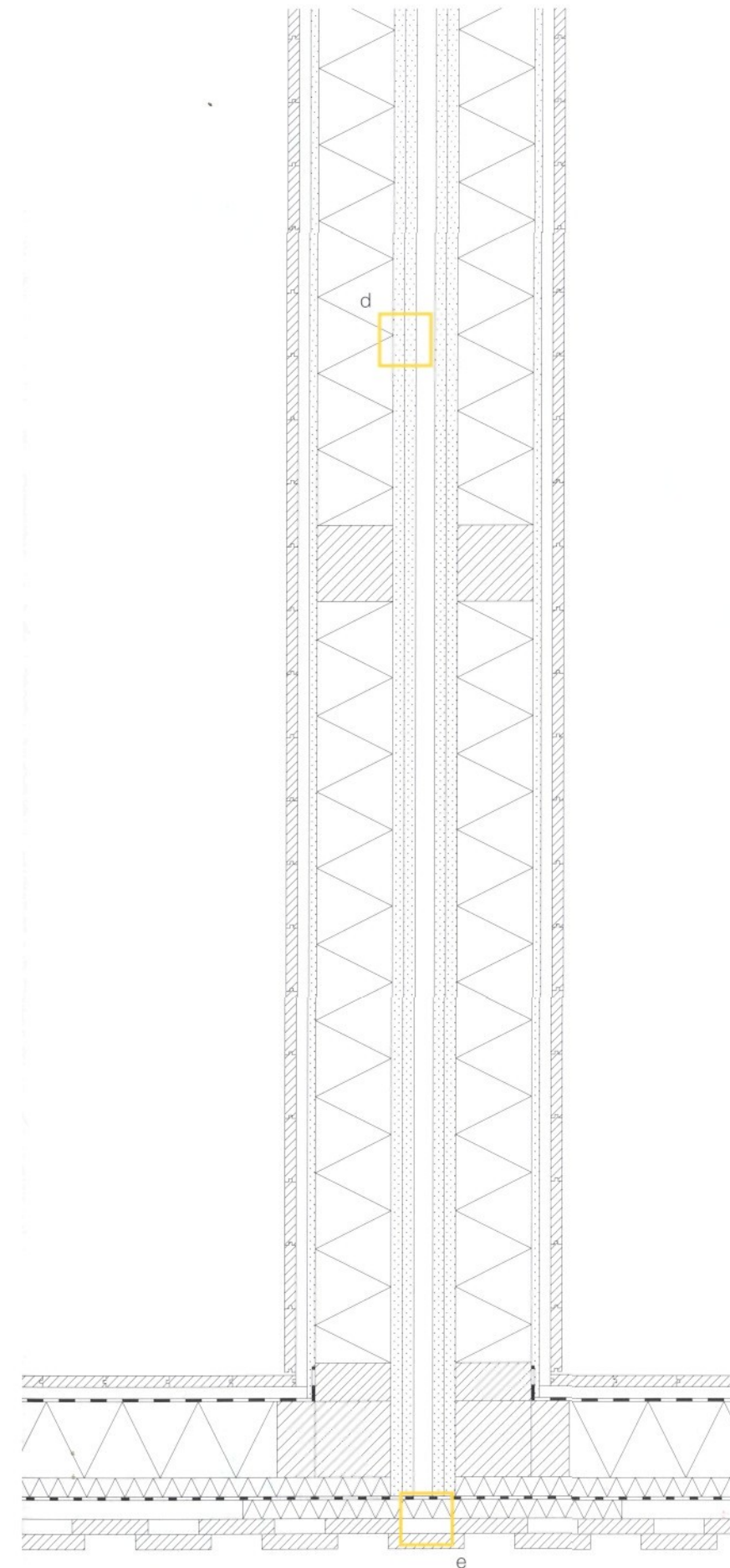
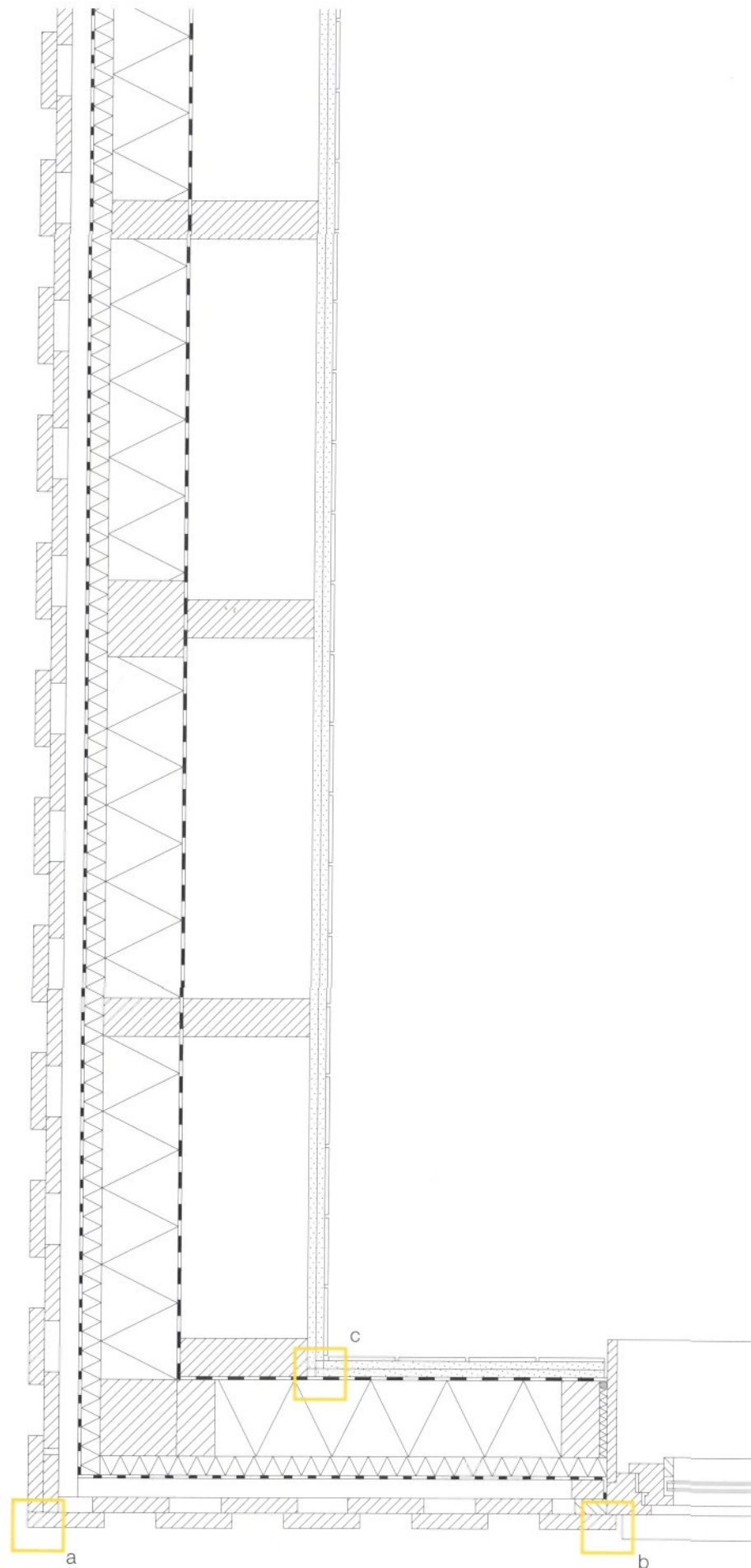

In the area of the shaft, the *vapour retarding layer* is fixed to the inside of the bearing structure to ensure that the service lines do not unnecessarily penetrate the *vapour retarding layer*. The floor structure continues through the services shaft. If lines run vertically, the ceiling boarding must be drilled or cut out to the size of the conduits.

Dd

According to the building regulations and DIN 4102, a party wall must comply with fire resistance class F 30 B on the room side and F 90 B in the cavity. These requirements are fulfilled on the interior by using a single layer of *planking* with 12.5 mm *fire-resistant plasterboard*. For the exterior, two-layers of *planking* with *fire-resistant plasterboard* (2 x 18 mm) are required. In the case of terraced houses, this requirement applies to both buildings. During construction, the side of the building must be planked before the wall is erected,

The expansion joint between the houses is not filled for reasons of *sound insulation*. A *vapour retarding layer* and *draughtproofing* are not necessary in the party wall. All things considered, this type of wall structure is a relatively costly and time-consuming affair. In timber construction, however, there is no recognised alternative to this approach.

e

Under the building regulations, a terraced house is a low-rise building whose party walls are constructed like compartment walls. In the cavity, the F 90 *planking* can end at the inside of the overlapping vertical *weatherboarding*. The boarding ventilation space must, however, be sealed with a non-flammable insulating material such as *mineral fibre* extending at least the width of the party wall. The boarding can be continued uninterrupted across the expansion joint.

- 22 Exterior wall, plinth
- 23 Interior wall, sole plate
- 24 Exterior wall, foundation
- 25 Interior wall, foundation
- 26 Exterior wall, floor/ceiling, window
- 27 Interior wall, floor/ceiling, door
- 28 Exterior wall, eaves
- 29 Exterior wall, verge
- 30 Exterior wall, corner
- 31 Party wall

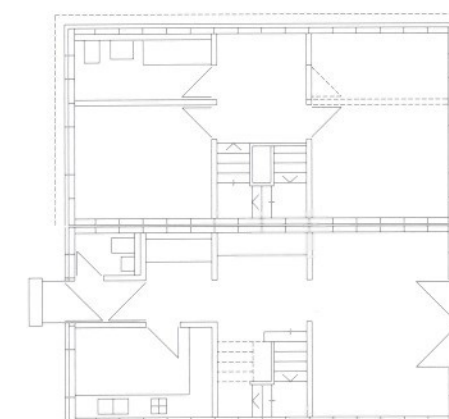
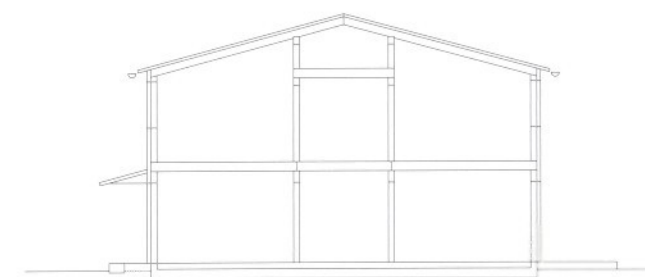

a

Before constructing a floating foundation with a load-bearing reinforced concrete slab on frost blanket gravel, it is first necessary to carry out preliminary investigations to determine the soil type and establish its bearing capacity. A rapidly draining, concentrated soil with a good bearing capacity is absolutely essential. The top layer of soil must be replaced by a layer of clean gravel approx. 40 cm deep, which is then carefully compressed and covered with a sub-base of 5-10 cm-thick grade B5 concrete on which the reinforced floor slab is cast.

Db

On the interior, the floor slab must be thermally insulated beneath the screed. The transition to the exterior wall is a weak point. This problem can be overcome (and the planned insulation standard maintained) by fitting impervious *thermal insulation* to the front side of the sole plate and covering the insulation either with a flat *fibre-cement slab* or concrete roofing tiles.

c

Prior to installing the prefabricated exterior wall elements, a *sill* is put in place, aligned, underlaid and fixed to the concrete slab with either lug angles and *dowels* or anchor bolts. The space between the *sill* and the floor slab is filled with high-expansion cement mortar. Since it is particularly exposed to hazards, the *sill* must be protected to meet *hazard class 2* requirements. Alternately, a very resistant wood species can be used, which will eliminate the need for chemical wood protection.

The *damp-proof course* on the floor slab is first bonded or welded to the seal beneath the sill. Then the plasterboard lining is attached to the elements, which are initially left unclad on the interior.

d

A permit must be obtained from the building supervisory authorities before the prefabricated insulated wall elements can be erected. Although these elements are subsequently panelled on both sides (clad elements), with most wooden constructions it is customary to panel them with *plywood sheeting* or *plasterboard* on the outside only at first, and to leave them unclad on the room side until they have

been fitted to the structural timbers (softwood timbers measuring 6 x 12 to 6 x 16 cm, depending on the insulation standard).

The above procedure makes it easier to fix the *sill* to the floor and install the wall elements.

If the *panelling* is to be used for reinforcement, permission must first be obtained from the building supervisory authorities. The elements are screwed to the construction, which is then sound insulated, vapour retarded and lined on the interior with *plasterboard* or *wood-based panels*.

If the interior panelling is to be attached directly to the structural timber elements, great care must be taken when planning the services, particularly the electric installations. If there is no alternative to connecting sockets to the exterior wall, protected sockets with an adhesive edge must be used. The sockets must be carefully bonded to the *vapour retarding layer* and provided with external insulation.

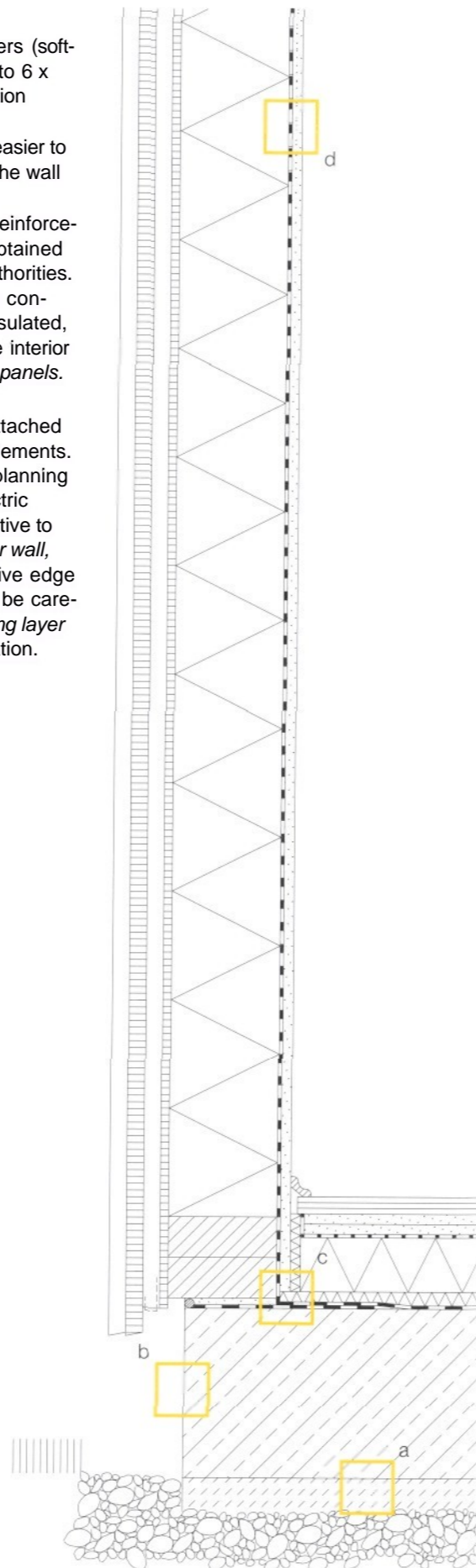

e

The height of the elements corresponds to that of the room(s), which, in turn, must comply with standard board dimensions. The element lengths partly depend on the method of transport and assembly used. Elements can extend the entire width of the house.

The interior wall elements, which must comply with the standard dimensions of board materials and construction timbers, comprise structural limbers made of *softwood* and measure 6/12 cm (centre distance = 62.5 cm). Like the exterior wall elements, they should initially be panelled on one side only. Once they have been constructed and installed, they should be clad with plasterboard or wooden panels. If the cavity between the structural timber elements has not been completely filled with expanded mica, *cellulose flakes*, etc., it should be filled with *mineral* or *coconut-fibre sound insulation* at least 30-40 mm or - preferably - 60 mm thick. Higher *sound-insulation* values can be obtained by applying double panelling or fitting additional "floating" panel cladding with flexible wall connections.

f

Appropriately bonded wooden panels or impregnated *plasterboard* (identification colour green) must be used in the humid rooms. *Gypsum fibreboard* has the advantage of not requiring additional treatment. Two layers of gypsum fibreboard will be necessary if humid rooms are to be tiled or the spacing between the structural timbers exceeds approx. 42 cm.

The shrinkage ratio of the noggings must be taken into account when attaching the *panelling*. Owing to their cross-section, this ratio is small and can be reduced still further by using pre-dried wood.

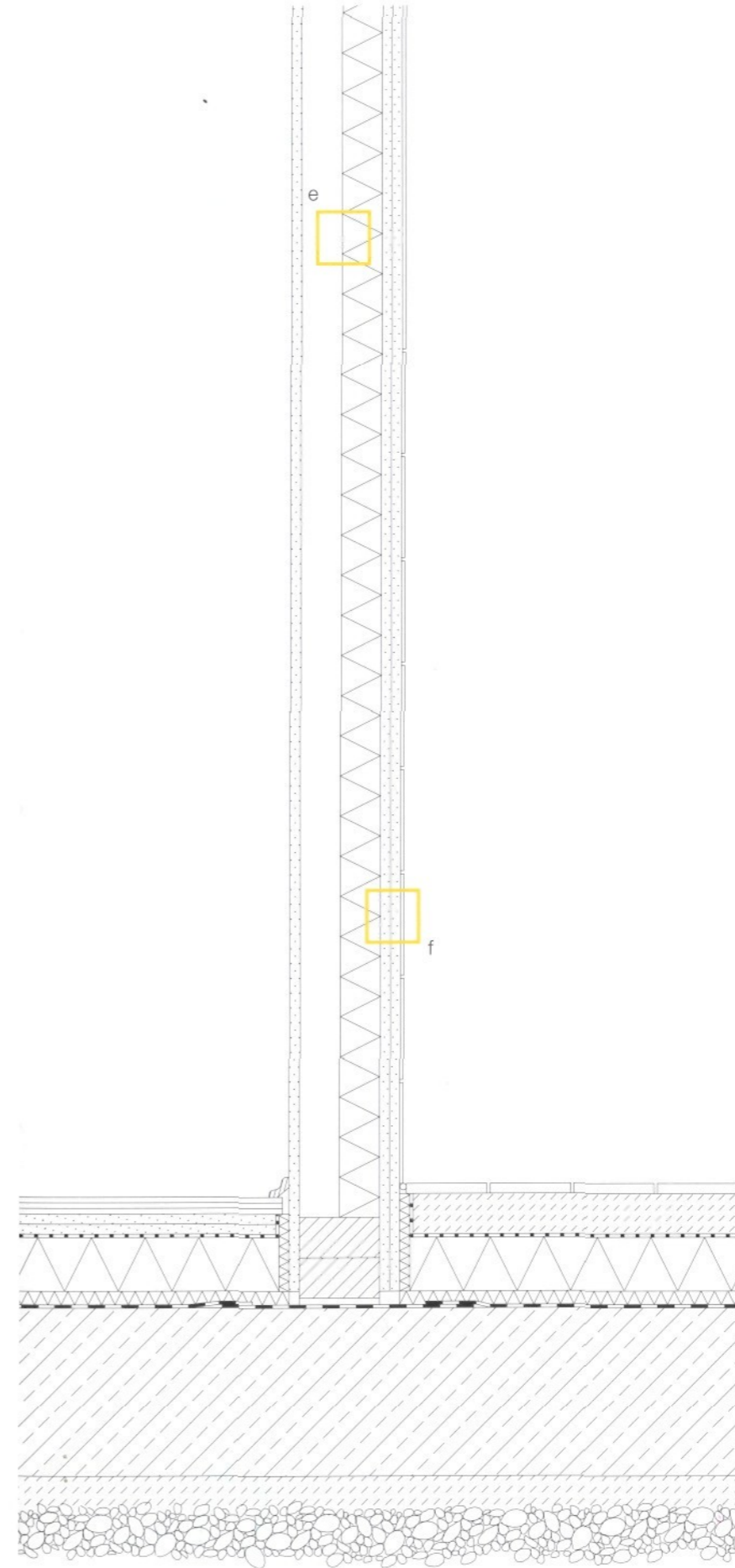

□ a

A different and perhaps more consistent approach to wood construction as a "dry" construction method is to use a *floor construction* comprising structural timber elements and with excellent thermal insulation, and to panel them on both sides. (These elements have dimensions of approx. 6 x 20 cm, determined statically and in accordance with insulation standards.) The rising walls are connected to the aligned and fixed floor elements. *Cemented chipboard* and *fibrated concrete slabs* make suitable underside panels.

The cavity between the infilling and the underside of the elements must be permanently ventilated. This can be done by installing correspondingly large grated openings on both sides of the terraced house.

□ b

Floating dry screed composed of wood, plasterboard, or *gypsum fibreboard* panels should be installed as a dry construction.

The *PE-foil* under the impact-sound insulation serves as a *vapour retarding layer* and simultaneously provides draught insulation.

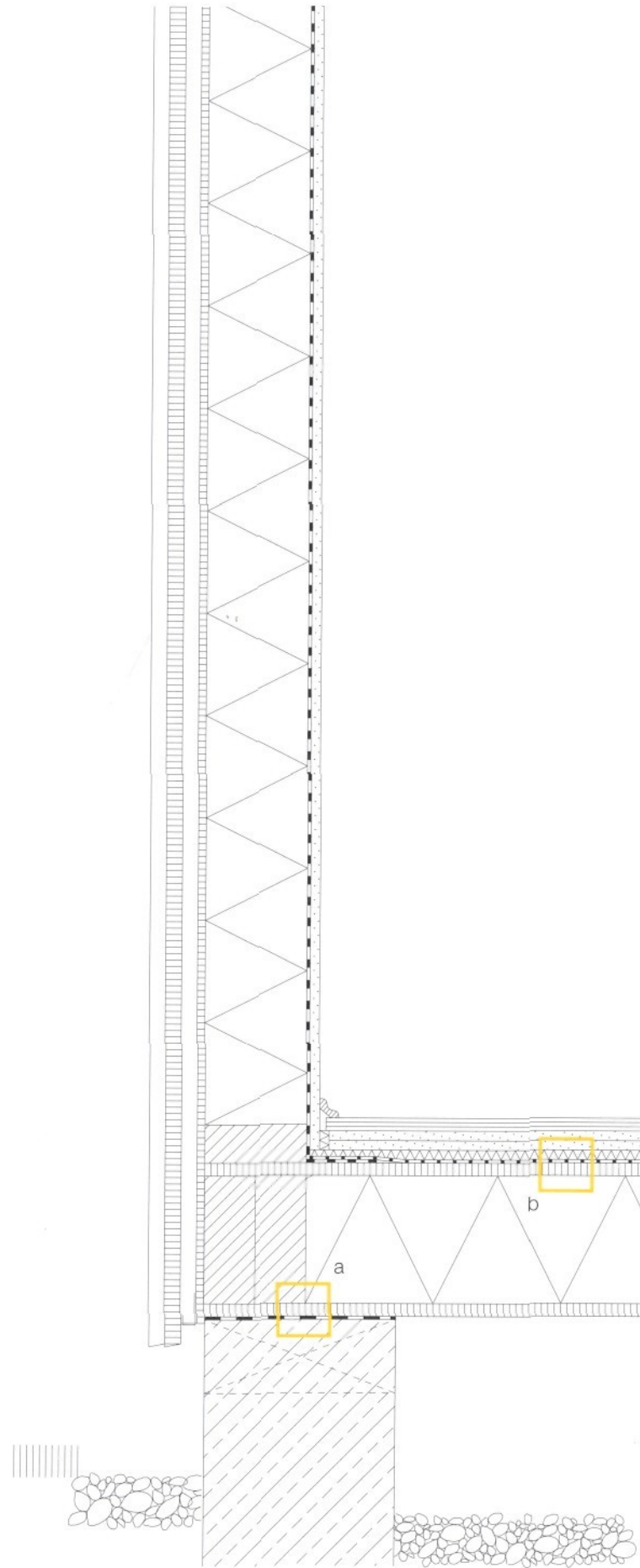

□ c

Beneath the interior walls, there is no need for frost-proof foundations or for continuous footing concreted to the soil or planked. The position of the footing is determined by that of the floor elements and the load-bearing interior walls. The floor elements should be formed as a plate and anchored to the foundation with authorised *dowels* or connection angles and stone bolts. *AW 100 plywood* strips or high-expansion cement mortar can be used to equalise out any unevenness. A *vapour barrier* of, say, polymeric bitumen or *plastic sheet* is fitted between the floor elements and the foundations to prevent any damage through moisture. The abutting joint between the elements must be sealed with insulating strips and *sealing tape*,

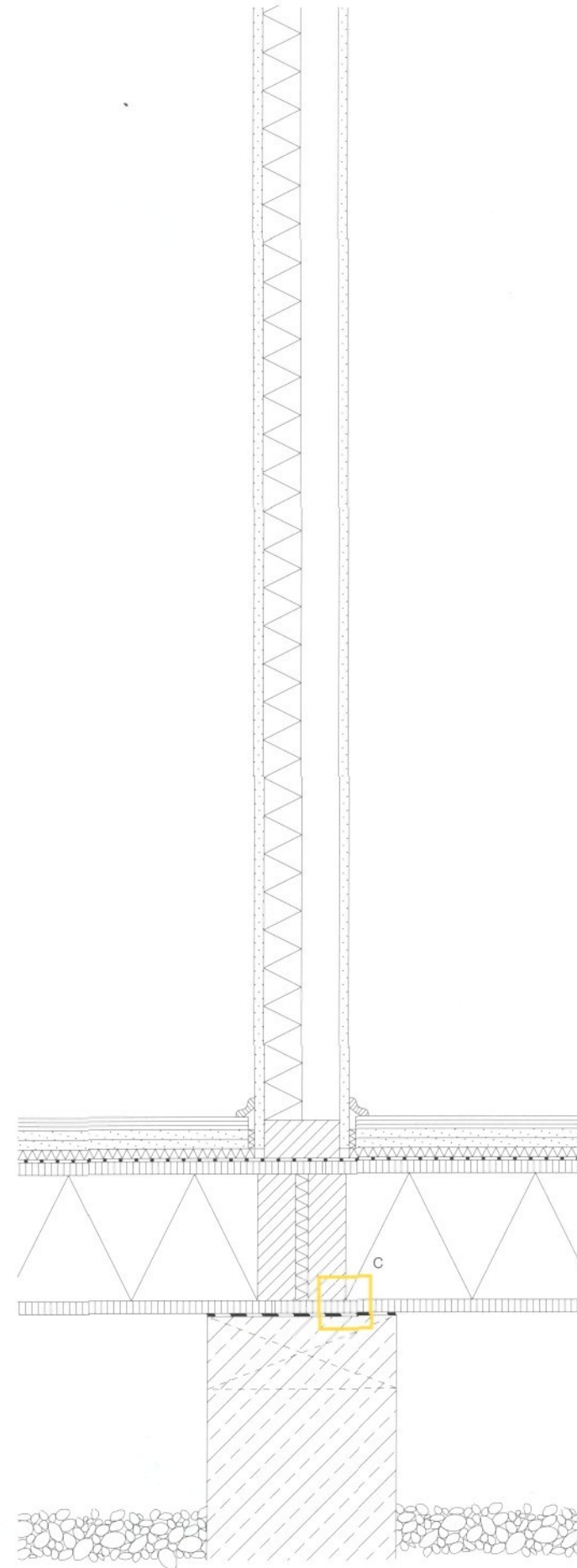

a

The wall elements are held together by, and aligned with, the upper headpiece. The floor, which is composed of *glued laminated beams* or *glued laminated timbers*, is fitted and bolted in element widths of between 60 and 250 cm (beams) or 62.5 and 100 cm (timbers). Mounting and shrinkage must be taken into account when choosing the width. During the construction phase, the wood - especially the solid elements - must be protected from the weather at all times to prevent damage through moisture and swelling.

If necessary, diaphragm action can be ensured by joining the elements to make them shear-resistant.

b

To ensure that the light, effectively insulated wooden waif fulfils its function, the *vapour retarding layer* must be connected to the wall at the floor edge in a way that allows for subsequent inspection. Correspondingly long sections of flexible *plastic sheeting* that allow for diffusion must be wrapped round the end of the floor and fixed on the upper side of the floor to the *vapour retarding layer* sheeting of the installed wall elements.

c

The selected assembly system and point in time when the exterior wall cladding is installed determine whether the surface-finished windows are assembled in the workshop or on site, and whether they are installed with or without glazing. The windows must be fitted to the structure with a section of vapour-resistant, flexible plastic that is fixed to the window frame.

The joint between the lintel and the window frame performs a vital function during installation in absorbing tolerances and movements. It should be filled with an insulating material (*mineral fibres, mineral wool, sheep's wool, etc.*) and sealed with a pre-compressed *seating tape* or permanently elastic sealing material. The stringent requirements of the energy conservation regulations must be observed (see also p. 14a).

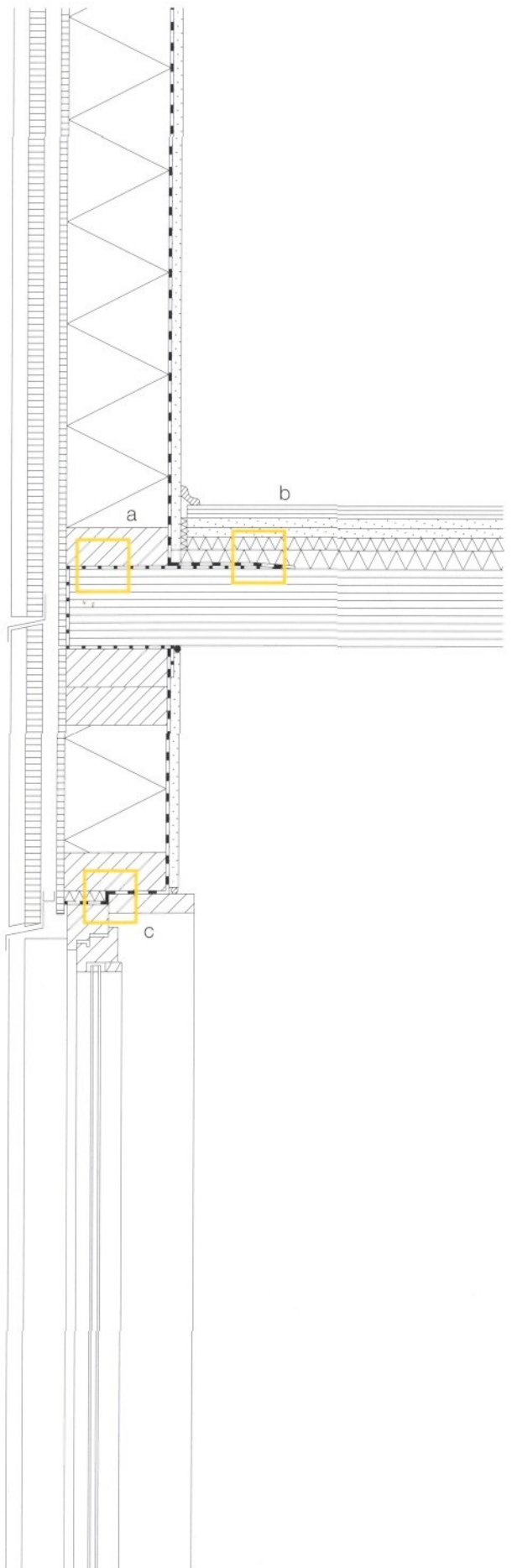

d

The ceiling's structural connection to the interior walls corresponds to that of the exterior walls. The problems related to fitting the *vapour retarding layer* and *draughtproofing* do not apply here.

e

The joint between the lintel and the door-frame is constructed in the same way as that of the window (see item c). The requirements of building physics concerning heat, vapour and draughts, which present considerable practical problems, do not apply here.

f

The floor structure, which is composed of *parquet, dry screed* and *impact insulation*, has been made 3 cm thicker than usual to include a services shaft which, in turn, accommodates the larger number of lines laid along the floor/ceiling. The problem of power-supply lines crossing one another can only be surmounted by careful planning.

Even with such a relatively "complex" ceiling structure, additional measures can be taken to improve airborne-sound insulation by, for example, using "sand honeycombs".

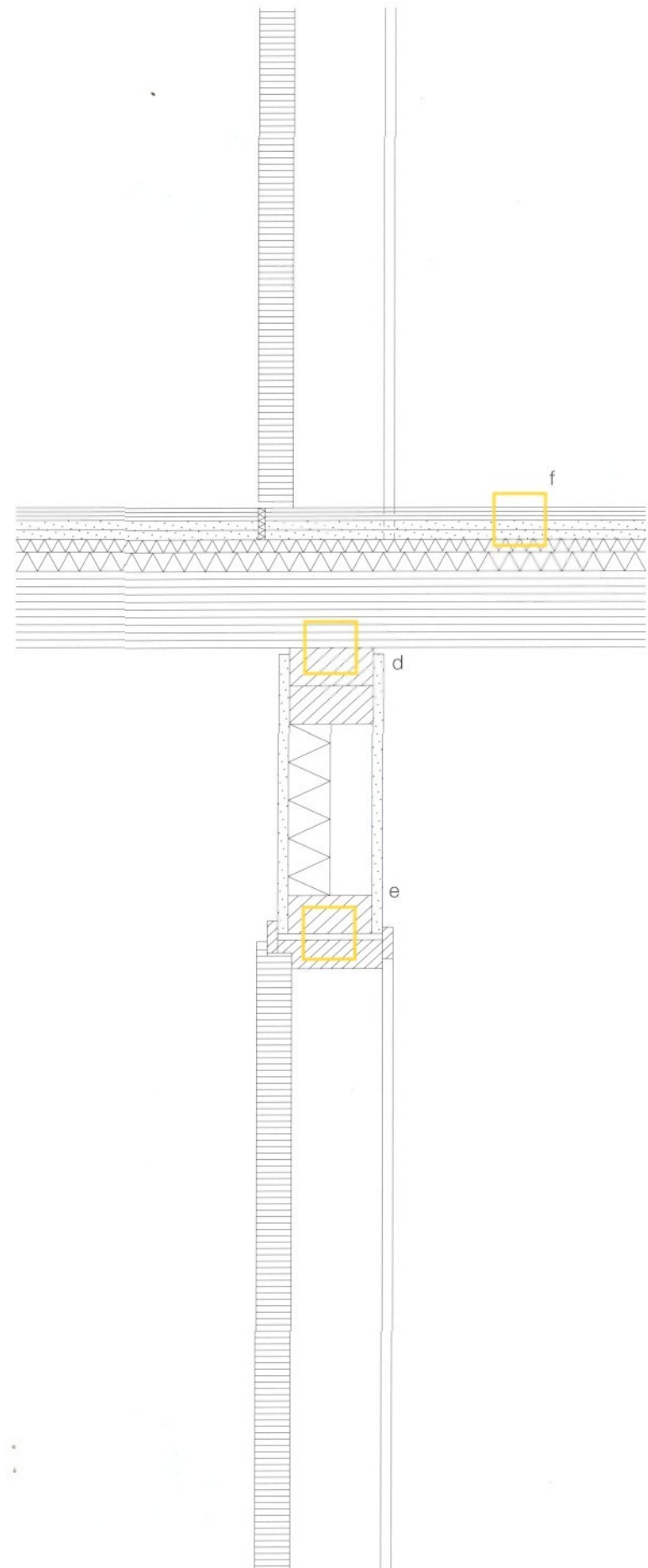

**a** a

The roof floor of *glued laminated beams* or *glued laminated timbers* is fitted to the support and screwed to the *sill*. As with the floor, a section of *plastic sheet* that allows diffusion is guided around the headpiece of the roof floor and fixed to the floor *vapour retarding layer*. The sheet ends must be either bonded together or well overlapped and fastened.

**b** b

The height of the cross rafters is determined by the thickness of the *thermal insulation*.

Covering the insulation with vapour permeable, water-repellent paper, or with *plastic sheeting* displaying the same qualities, ensures that any precipitation (rain, drifting snow...) or "secondary" meltwater (changes in weather or cold night air that cools the underside of the non-sucking roofing material) can drain off, and that there is no reduction in insulation value. Ventilation and drainage are ensured by counter battens and a triangular cleat of perforated plate, which is fixed to the eaves flashing with tingles.

The eaves flashing rests on a plywood strip, for which the cross-rafters are cut out. It is advisable to bolt the flush countersunk gutter hanger onto a continuous fascia.

**c** c

The dimensions and spacing chosen for the rafter-supporting purlins depend on the corrugated sheet roofing used.

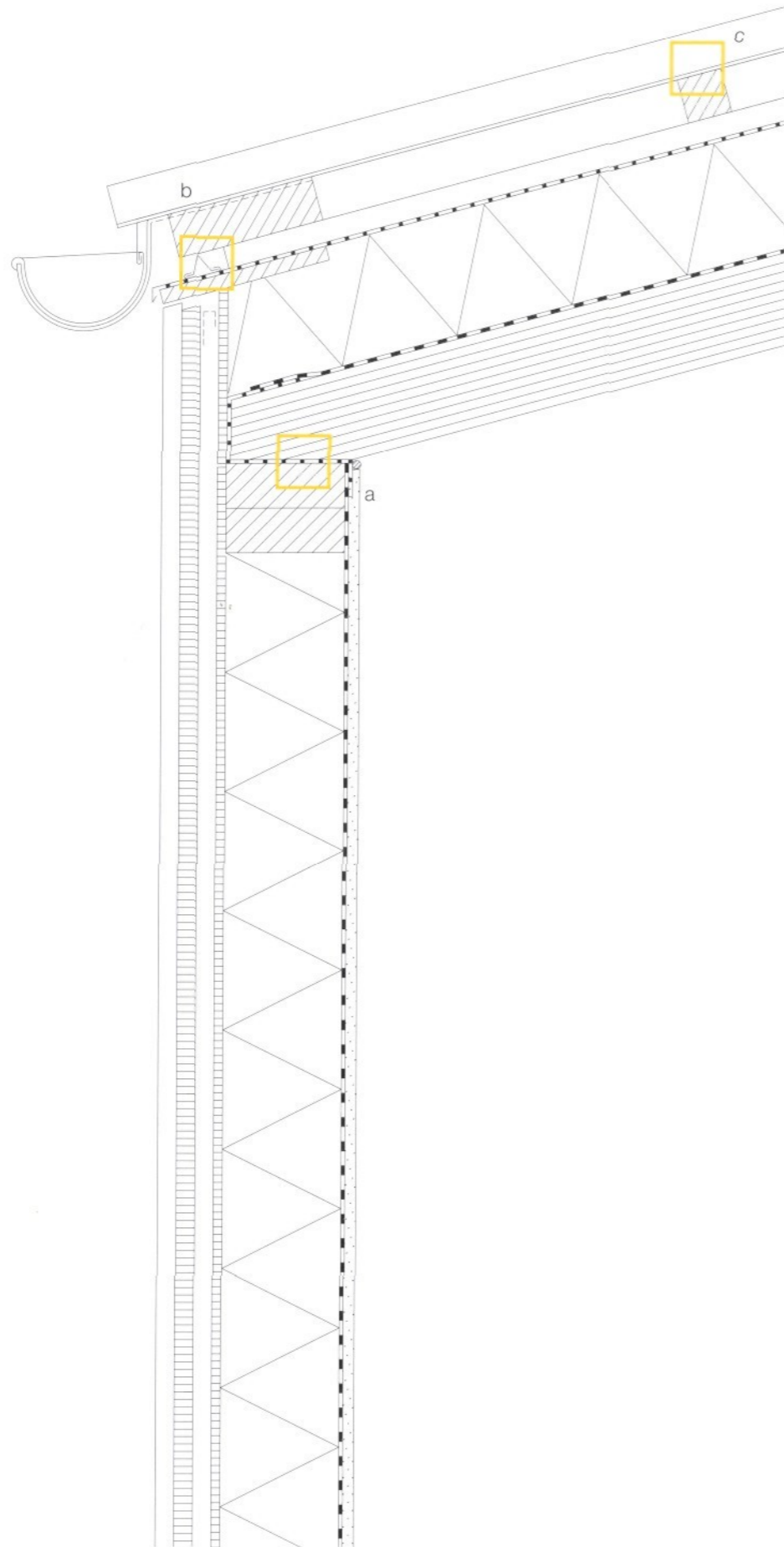

**d** d

The width of the insulating panels must be greater than the clear spacing of the cross rafters to accommodate the slightly compacted *thermal insulation* installed between them, which has to compensate for any wood shrinkage. The division of the substructure into cross-rafters and counter battens ensures that the vapour-permeable protective layer is level and remains securely fixed.

The main goal here (depending on the thermal-insulation requirements for the roof) is to ensure that the continuous rafters do not create a thermal bridge. This can be avoided by installing a second insulating layer, as shown in the example here. Another solution is to place insulation beneath the foil between the horizontal counter battens, or to install continuous bituminous *fibreboard* decking, which simultaneously acts as a protective layer.

**e** e

The efficiency of the various insulating measures and the utility of a house largely depends on whether the protective layers, which take the diverse loads imposed on a building (thermal, moisture, air), can be applied consistently and safely to all connections. They must also be open to inspection.

The storage capacity of the heavy roof members improves thermal protection during the summer.

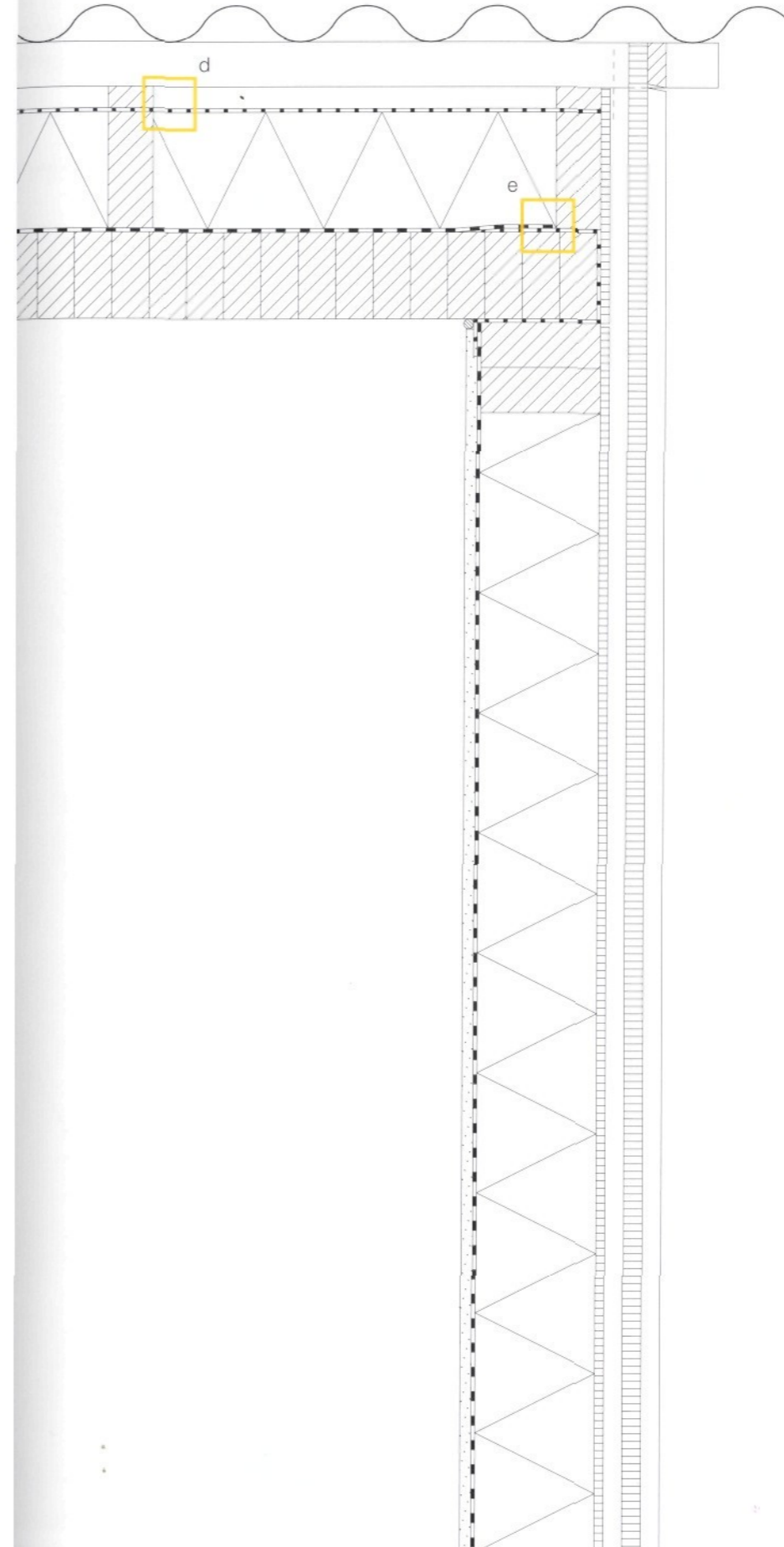

● a

If the substructure unit spacing of 62.5 cm is observed, the plywood panels (which are generally 125 cm wide) can be screwed in the centre of the panels and at their edges. The width of the cover strips has to be calculated accurately to ensure that the edge spacing of the screws is sufficient, and to fully cover the screw heads. Narrower cover strips should not be used unless an alternative way is found of fixing the facing panels (e.g. by screwing them onto more closely spaced substructure elements) and the panel edges only has to be cramped by the screwed-down cover strips.

Although the absence of a visible bolted connection (with a shadow gap, sealing tape and a correspondingly wide substructure) on a smooth large plywood cladding panel does justice to the material, it nevertheless exposes the panel edges. This, in turn, makes it almost impossible to prevent water absorption and heightens the risk of damage or movement from swelling and shrinkage. The following protective measures can be taken here: reduce the weather loads, e.g. by circumspect alignment of the building, use large roof overhangs or cantilevered balcony slabs, and give all edges water-repellent treatment. As these precautions were not taken in the example presented here, a more resistant joint was chosen and secured with cover strips.

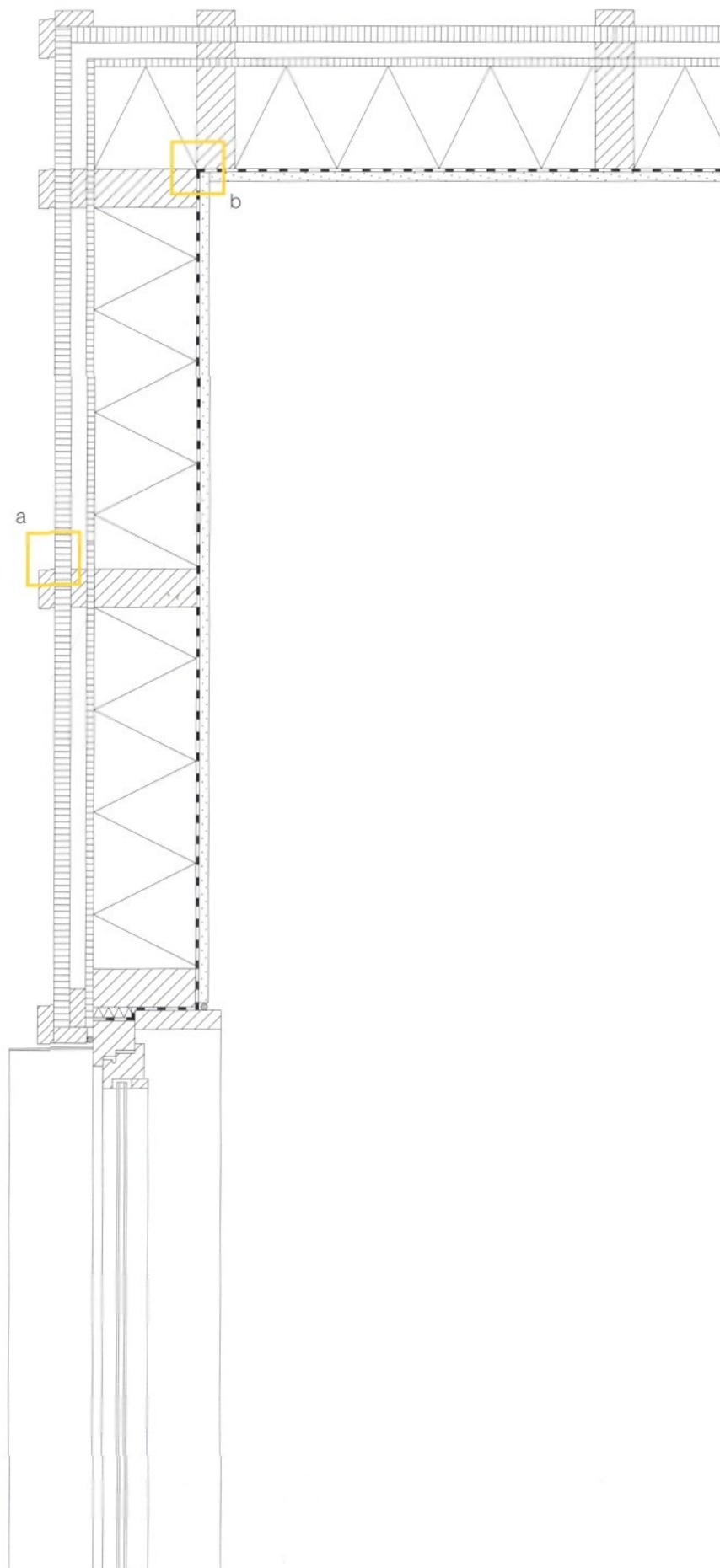

Db

The elements are jointed at the corner. Although the corner design shown here is atypical for wooden frame constructions, it does make it easier to connect the elements in an open corner joint. After it has been screwed together, the corner must be sealed on the outside with a prefabricated, thermally insulated metal angle.

The greater requirements (regarding building physics!) placed on the exposed outside corner mean that considerable care must be taken when installing the *thermal insulation* and the *vapour retarding layer*. The joint must be completely packed with insulating material (filling, injecting) and the angle sealed with tape (butyl, for instance) beneath the overlapping joint of the *vapour retarding layer* (nailed/clamped and bonded).

□ c

According to the Building Regulations and DIN 4102 T-4, party walls must have a fire-resistance class of F 30-B (interior) and F 90-B (exterior). These requirements can be met using *glued laminated beams* or *glued laminated timber* elements which are panelled accordingly on the outside (in contrast to the procedure adopted for House A). If this method is chosen, the construction must be inspected and a permit may have to be obtained. As an alternative to leaving an air space between the party walls, an elastic *insulating material* could be used here (e.g. building class A, melting point > 1000 °C).

● d

It is necessary to establish the required acoustic reduction (required  $B_w = 57$  dB or 67 dB for greater sound insulation). Sound insulation can be improved even more with an interior facing shell of *plasterboard panels* on spring shackles.

□ e

The expansion joint must extend to the outer edge of the *exterior wall*. The width of the non-flammable backfill insulation must be established in co-operation with the responsible authority.

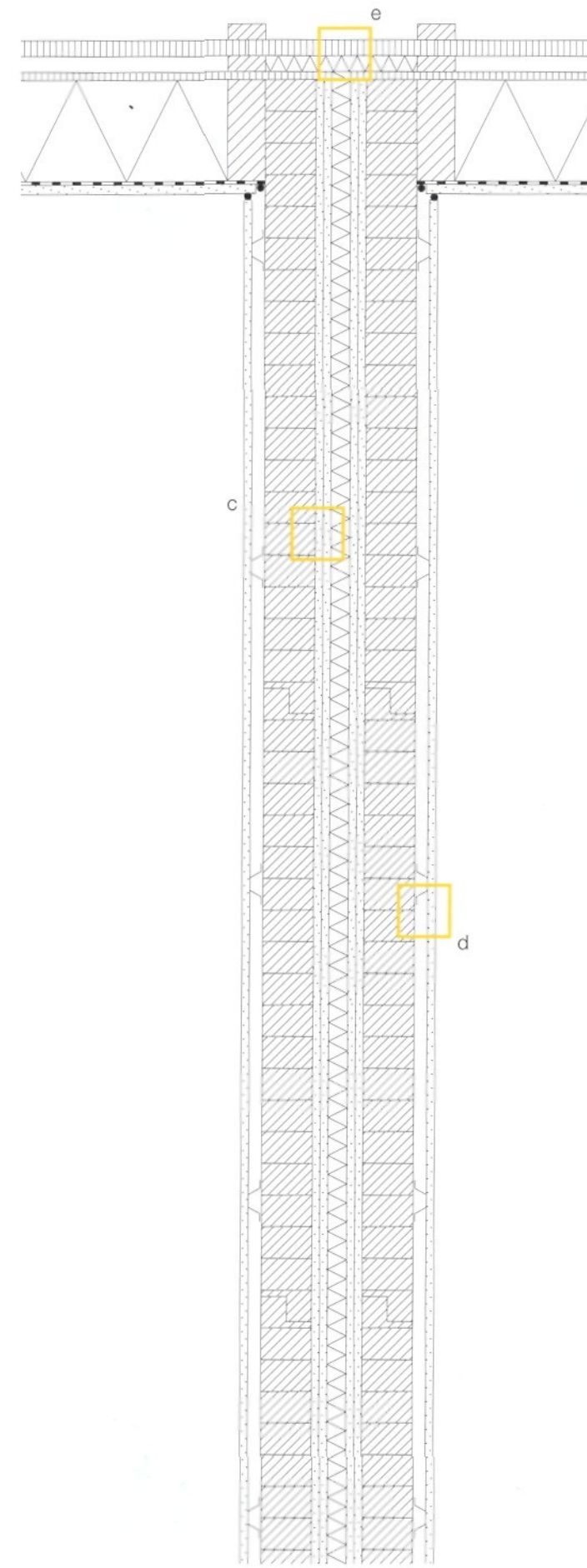

## Products

## Timber

- 34 Solid wood
- 35 Structural solid wood
- 36 Glued laminated timber
- 37 Glued laminated beams
- 38 Boards/planks
- 39 Profile boards

## Manufactured Wood Products

- 40 Blockboard and laminated board
- 41 Three- and five-ply panels
- 42 Laminated construction board
- 43 Parallel laminated veneer
- 44 Parallel strand lumber
- 45 Laminated strand lumber
- 46 Oriented strand board
- 47 Fibreboard
- 48 Flat-pressed boards
- 49 Extruded particle boards
- 50 Fibre-Reinforced cement boards

## Building Boards

- 51 Fibre cement boards
- 52 Plasterboard
- 53 Gypsum fibreboard

## Insulating Materials

- 54 Wood fibre
- 55 Bituminated fibreboard
- 56 Cork
- 57 Expandable polystyrene
- 58 Extruded polystyrene
- 59 Polyurethane
- 60 Mineral wool
- 61 Sheep's wool/cotton wool
- 62 Flax/hemp
- 63 Coconut fibre
- 64 Cellulose
- 65 Perlite/swelling clay

## Sheathing paper

- 66 Vapour retarding layer/vapour barrisr
- 67 Damp-proofing
- 68 Product overview

## Joints and Fasteners

- 70 Dowels
- 71 Anchors/bolts
- 72 Screws/staples
- 73 Nails/Nail Plates
- 74 Sheet steel brackets

- 76 Wood preservation

- 78 Joint sealing tapes





**Solid Wood**

DIN 1052-1  
DIN 4074-1  
DIN 68365  
DIN EN 350-2  
Thermal conductivity:  
= 0.13 W/mK  
Vapour diffusion resistance factor:  
H = 40  
Raw density: dependent on timber species  
p - 450-800 kg/nV  
Computation weight in accordance with DIN 1055-1:  
4-6kN/m<sup>3</sup>

Building material classification:  
B2  
Thermal capacity:  
C = 350 kJ/m<sup>2</sup>K  
Wood moisture content:  
as dry structural wood < 20 %  
Amount of swelling and shrinkage per % change in wood moisture  
0.24 % across the grain

Commonly used timber species  
• spruce  
• fir  
• pine  
• larch  
• Douglas fir

**Dimensions**  
Cross-section dimensions for square timber stock [cm]:  
6/6, 6/8, 6/12,  
8/8, 8/10, 8/12, 8/16  
10/10, 10/12, 10/20, 10/22  
12/12, 12/14, 12/16, 12/20, 12/24  
14/14, 14/16,  
16/16, 16/18, 16/20,  
18/22  
20/20, 20/24  
Length:  
depending on the sawing facilities of the sawmill: up to 16 m.

**Material**

- Solid wood is debarked round timber and converted building timber (squared timber, planks, boards and laths) of softwood (coniferous wood) and hardwood (wood from deciduous trees).
- Structural timber is round wood or sawn timber. The cross-sections of load-bearing building elements are dimensioned in relation to the load-bearing capacity of the wood species in question.
- Converted building timbers are laths, planks and squared (softwood) timber. The following types of sawn timber are distinguished according to their thickness-to-width ratio:

	Thickness d Height h [mm]	Width b Jmm]
Lath	d < .40	<b>b &lt; 80</b>
Board	d < :40	<b>b : &gt; 80</b>
Plank	d > 40	b > 3d
Squared timber	b/fh < .3b	b > 40

**Use**

Sawn softwood may be used in all areas of construction. When load-bearing timbers are used for external building elements, appropriate measures must be taken to preserve the wood (treatment with chemicals or structural reinforcement). In order to minimise fluctuations in wood moisture as well as the related negative consequences brought about by shrinkage and swelling, the moisture content of the wood used should correspond to its moisture content in service.

**In-servicemoisturecontent:**  
Heated buildings enclosed on all sides  
9 ± 3 %  
Without heating  
12 ± 3 %  
Covered, open buildings  
15 ± 3 %  
Constructions exposed to the weather on all sides 18 ± 6 %

- For invitations to tender and orders:
- Sawn wood species
  - DIN
  - Grade
  - Wood species
  - Sawn wood grade
  - Wood moisture
  - Thickness/height
  - Width
  - Length
- Calculated per m/m<sup>3</sup>

**Grading**

Structural wood, which is dimensioned in relation to its load-bearing capacity, must be graded mechanically, in relation to its load-bearing capacity, prior to use.

- Depending on the grading procedure, the moduli of elasticity, raw density, knottiness and grain deviation are recorded and the sawn timbers graded. The mechanical grades are: MS 7, MS 10, MS 13, MS 17 (see appendix)
- When wood is graded visually, the following characteristics have to be considered: the wane, knots, annual-ring width, slope of grain, cracks, stains, compression wood, insect damage, mistletoe attack and warp. The visual grades are: S 7, S 10, S 13 (see appendix). The DIN standards S 7, S 10, S 13 correspond to the old quality classes I, II, III.

There is no difference between visual and mechanical grades with respect to load-bearing capacity.

Sawn timber grades:

Sawn-wood grade	Grading	Permissible wane
S	-	-
A	S13	1/8
B	S10	1/3
C	S7	Saw-marked sides

**Manufacturerfs)**  
Converted building timber is available directly from sawmills as dimensional timber (square timber stock) and can be ordered in a wide variety of cross-section dimensions and lengths.

**Information**  
Bundesverband Deutscher Holzhandel e.V.  
Bund Deutscher Zimmermeister e.V.  
Lignum  
Proholz



**Structural Solid Wood**

DIN 1052-1  
DIN 1052-1/A1  
DIN 4074-1  
Thermal conductivity:  
= 0.13 W/mK  
Vapour diffusion resistance factor:  
H = 40  
Raw density:  
p = 470-590 kg/m<sup>3</sup>  
Computation weight according to DIN 1055-1: 4-6 kN/m<sup>3</sup>  
Building material classification:  
B2  
Wood moisture content:  
15 ± 3 %  
Amount of swelling and shrinkage per % change in wood moisture  
0.24 % across the grain

Wood species:  
• spruce  
• fir  
• pine  
• larch

**Dimensions (mmj)**  
60x120/140/160/180  
60 x 200/240  
80 x 120/140/160/200/240  
100x120/200  
120x120/200/240  
Length: with finger jointing any number of lengths is possible

**Material**

Structural solid wood is a converted building pinewood which, due to its field of application, is subject to very stringent requirements. Its load-bearing capacity (S 10) and appearance are graded according to the DIN 4044-1 hardwood standard. Additional requirements apply which go beyond DIN 4074-1 with respect to wood moisture content, dimensional stability/size consistency, sawing method, limitation of crack width, and - in the case of visible building elements - surface quality.

**identification**  
The product must display a kite mark. In addition, it must bear the kite mark of the Überwachungsgemeinschaft Konstruktionsvollholz aus deutscher Produktion e.V. (accreditation body for German solid structural wood products).

**Use**  
Structural solid wood is primarily used when the wood used has to fulfil strict requirements concerning its load-bearing capacity, appearance, dimensional accuracy and shape retention. In wooden house construction, structural solid wood is used primarily in the construction of fully insulated structures.

As the wood has a moisture content of 15 ± 3 %, it need not be treated with chemical preservatives.

- For invitations to tender and orders:
- Structural solid wood
  - Identification
  - Wood species
  - Thickness/height
  - Width
  - Length
  - Surface
- Calculated per m/m<sup>3</sup>

**Manufacture**  
Wood finishes are categorised according to use:

- structural solid timber for visible structures (planed and chamfered)
- structural solid timber for concealed structures (levelled and chamfered, with the heart plank removed)

In both cases, finger jointing is permissible as spring-actuated longitudinal jointing. This type of jointing does not weaken the cross section of the wood and need not be taken into account during stress detection.

In the case of visible structural solid timber, a heart-free cut is obligatory for cross sections of up to 100 mm. This is made by removing a 40 mm-thick heart plank, A heart-free cut is obligatory for all other cross-sectional thicknesses and for the entire range of visible structural solid woods.

**Manufacturerfs)(selection)**  
Ante-Holz GmbH  
Eugen Decker Holzindustrie  
Ambros Fichtner Holzwerk  
Anton Heggenstaller AG  
Anton Hess GmbH+Co KG  
Hulster-Holz GmbH & Co.KG  
Johann Kirchhoff GmbH  
Merkle Holz GmbH  
Rettenmeier GmbH & Co.KG  
Holz Schmidt GmbH  
Schollmayer Holz GmbH  
Matthaus Sturm GmbH  
Holzwerke Wimmer GmbH

**Information**  
Überwachungsgemeinschaft Konstruktionsvollholz aus deutscher Produktion e.V.  
Bund Deutscher Zimmermeister e.V.  
Bundesverband Deutscher Holzhandel e.V.



**Glued Laminated Timber**

DIN 1052-1/A1 EC 5  
DIN 4074-1  
Thermal conductivity:  
 $\lambda_{0.10} = 0.13 \text{ W/mK}$   
Vapour diffusion resistance factor:  
 $\mu = 40$   
Raw density - depending on the wood species:  
 $\rho = 450-800 \text{ kg/m}^3$   
Building material classification:  
B2  
Computation weight in accordance with DIN 1055-1:  
4 to 5 kN/m<sup>3</sup>  
Wood moisture content:  
8-12%  
Amount of swelling and shrinkage per % change in wood moisture:  
0.24 % across the grain  
Wood species:  
• spruce, fir, larch  
• Douglas fir, Western hemlock,  
• Southern pine, Yellow cedar  
Types of glue:  
Urea-formaldehyde resin (UF)  
Melamine modified urea-formaldehyde resin (MUF)  
Phenol resorcinol resin (PRF)  
Polyurethane (PU)

**Dimensions**  
Recommended width [cm]: 8-22  
Height [cm]: up to 200  
The height-to-width (h/w) ratio of 1/10 must not be exceeded  
Length [m]: up to 30.  
Overlengths or up to 50 m are possible (check for transportability)

**Material**  
Glue-laminated timber is a modified solid wood in which the weakening influence of growth-related defects has been largely cancelled out.  
Glued laminated timber is composed of at least three sheets of softwood timber glued under pressure, parallel to the grain, to create stable building elements.

Glued laminated timber grades

Glued laminated timber grade	Grade of laminates
BS11	S 10, MS 10
BS14	S13
BS 16	MS 13
BS18	MS 17

**Use**  
Synthetic resin glues with a urea-formaldehyde resin basis may be used for non-water-resistant gluing. The glued joint is light in colour and barely distinguishable from the wood.  
If water-resistant gluing is required, synthetic resin glues with a phenol, resorcin, melamine or polyurethane basis must be used. Phenol and resorcin resins are identifiable by the dark-brown glued joints they make, whereas modified melamine resins are light to chocolate-brown in colour. Polyurethane joints are light and transparent.

Glued laminated timber that is exposed directly to the vicissitudes of the weather requires additional chemical treatment with oleaginous wood preservatives.

For invitations to tender and orders;  
• Wood species  
• Glued laminated timber grade  
• Width, height, length  
• Gluing  
• Surface  
• Wood preservation measures  
Calculated per m<sup>3</sup>

**Manufacture**  
The individual laminates used to make glued laminated timber must be at least 6mm thick and not exceed 33 mm. Straight building components may be 42 mm thick provided that they are not subject to extreme, climatically induced load changes.

The laminates are dried and planed. All natural defects such as excessively large knots and pieces of bark are removed mechanically. Abutments are staggered and glued as finger joints and clamp pressed.

Load-bearing components may only be manufactured by authorised enterprises. These components must be clearly identified with kite marks.

**Manufacturers}{selection}**  
Achberger Ingenieur Holzbau GmbH  
Grossmann Bau GmbH  
Haas Fertigung GmbH  
Härle Karl GmbH  
Kaufmann Holzbauwerk  
Maier Holzbau GmbH  
Merk Holzbau GmbH  
Zeh Ulrich GmbH&Co.KG

**Information**  
Deutsche Gesellschaft für Holzforschung e.V. DGfH  
Studiengemeinschaft Holzleimbau e.V.,  
Gütegemeinschaft BS-Holz e.V.  
Otto-Graf-Institut



**Glued Laminated Beams**

Non-standardised  
They may only be used if permission is granted on the basis of the local Building Regulations in each individual case.

thermal conductivity:  
 $\lambda_{0.10} = 0.13 \text{ W/mK}$   
Vapour diffusion resistance factor:  
 $\mu = 40$   
Raw density:  
 $\rho = 450-800 \text{ kg/m}^3$  depending on the wood species used  
Computation weight in accordance with •DIN 1055-1:  
4-5 kN/m<sup>3</sup>  
Building material classification:  
B2  
Thermal capacity:  
 $C = 350 \text{ kJ/m}^3\text{K}$   
Wood moisture content:  
 $15 \pm 3 \%$   
Amount of swelling and shrinkage per percentage change in wood moisture:  
0.24 % across the grain

**Dimensions**  
Beam height [cm]:  
Walls 6,8-12  
Floors/ceilings 12-24

**Material**  
Glued laminated beams are solid, flat, building elements. They are composed of layers of boards or planks connected to each other with nails or hardwood drift bolts. The quality of the original material is not subject to particularly high minimal requirements. Laminations of grades S7/S10 are sufficient. Side boards can be used. Although there are no obligatory lamination thicknesses, the customary sawmill thicknesses of 24-32 mm, or up to 60 mm in special cases, are recommended. Boards and planks with thicknesses between 32 mm and 45 mm are often used for visible structures.

**Use**  
Floors, ceilings, roofs, (both bearing and non-bearing) can be constructed with glued laminated beams. The individual beams are used vertically in the wall elements.  
Additional measures can be taken if diaphragm action is desired.  
The individual elements are connected with groove-and-tongue joints, rebates or flat steel connections. Swelling and shrinkage must be taken into consideration when selecting element widths. In order to avoid swelling, the wood must be effectively weatherproofed to protect it during transport, storage and installation.

This system, which has a high load-bearing capacity, allows for extremely slender cross sections. A variety of composite construction systems involving the use of concrete are available on the market.

For invitations to tender and orders:  
- Manufacturer  
• Wood species  
• Thickness/width/length  
• Surface  
Calculated per m/m<sup>l</sup>

**Manufacture**  
Glued laminated beams are generally prefabricated. After the laminations have been dried to a wood moisture content of 15 + 3% they are levelled, arranged close together lengthways, and glued with staggered joints in a continuous process. Laminations of the same thickness and width are used. The coupling force can be transferred to the lamination joints by using more nails, or by gluing or finger jointing. The joint can be strengthened by using profiled boards on the faces.

Floor/ceiling openings and other openings must be taken into consideration when manufacturing glued laminated beams.

The elements can be prefabricated in lengths of up to 2.40 m, depending on transportability. Lengths should not exceed 12 m.

**Manufacturer(s){selection}**  
Bau-Barth-Holzbaulemente  
Holzbau Becke & Sohn GmbH  
Hiwo Holzindustrie Waldburg zu Wolfegg GmbH & Co. KG  
Rudolf Janssen GmbH & Co. KG  
Kaufmann Holzbauwerke  
Kaufmann Massivholz GmbH  
Kobus

**Information**  
Fachagentur Holz  
Bund Deutscher Zimmermeister



**Boards/Planks**

DIN 4071-1  
DIN 4071-1  
Thermal conductivity:  
 $k_{\perp} = 0.13W/mK$   
Vapour diffusion resistance factor:  
 $H = 40$   
Raw density:  
 $\rho = 350-500 \text{ kg/m}^3$  depending on the wood species used  
Computation weight in accordance with DIN 1055-1:  
 $4-6 \text{ kN/m}^3$   
Building material classification:  
B2  
Thermal capacity:  
 $C = 350 \text{ kJ/mK}$   
Wood moisture content:  
Equivalent to equilibrium moisture content < 20 %  
Amount of swelling and shrinkage per % change in wood moisture  
0.24 % across the grain

Wood species:  
• spruce, fir, pine  
• larch, Douglas fir  
• Northern softwood species for planed assortments

*Dimensions*  
Thickness, unplaned [mm]:  
16, 18,22,24, 28,38,44,48, 50, 63, 70, 75  
Thickness, planed [mm]:  
13.5, 15.5, 19.5, 25.5, 35.5, 41.5, 45.5  
Thickness, northern woods, planed [mm]:  
9,5, 11, 12.5, 14, 16,22.5, 25.5, 28.5, 40, 45  
Width [mm]:  
75, 80, 100, 115, 120, 125, 140, 150, 160, 175  
Length [mm]:  
1,500-6,000  
Gradations [mm]:  
250, 300

*Material*

Unplaned softwood boards and planks are parallel square-edged materials. Planed softwood boards and planks are planed smooth on one side and processed to an even thickness on the back. The edges are neither planed nor profiled.

*Use*

Unplaned and planed boards and planks are used for shuttering, external cladding and the most diverse areas of construction. When boards and planks are used for structures that have to be dimensioned in relation to load-bearing capacity, they must meet the requirements of DIN 1052 and be graded in accordance with DIN 4074-1. If the boards do not have to perform a load-bearing or reinforcing function, there is no necessity under German building regulations to take preventive measures to preserve the wood. It is advisable to use load-bearing lathing with a cross section of 30 x 50 mm (minimum cross section 24 x 48 mm) to affix the cladding. These cross sections are available as dry wood from trade stores: cross sections with an average moisture content of  $15 \pm 3 \%$  can also be obtained by invitation to tender. Visible joints and fastenings for external use must be made of galvanised steel or - better still - chromium-nickel stainless steel.

The spacing of the load-bearing lathing depends on board thickness:

Board thickness [mm]	Lathing spacing [mm]
18.0	400-550
19.5	500-700
22.0	550-800
24.0	600-900
25.5	700-950
28,0	800-1.050

For invitations to tender and orders:

- Classification -DIN
  - Grading
  - Wood species
  - Thickness
  - Width
  - Length
- Calculated per  $m^2/m^3$

*Manufacture*

Boards and planks are sawn from round timber in sawmills or milled in planing mills and then planed, if necessary. Their dimensions and thickness-to-width ratio are their distinguishing features.

	Thickness (t) [mm]	Width (w) [mm]
Board	$t \leq 40$	$w \geq 80$
Plank	$t > 40$	$w > 3t$

If boards are to be used externally, they must be treated with a preventive structural wood preservative. Careful planning and execution are essential.

If boards are exposed to weather, they should not be made of pine as it invariably has sap rot and blue stain. Their sap is particularly susceptible to wood-decaying and wood-staining fungi, which not only damage the wood but also cause paint failure.

To avoid changes in form in internal areas, the wood moisture content must be stated when placing orders. It is advisable to ventilate the wood cladding.

*Manufacturer(s)*

Boards and planks, both planed and unplaned, can be obtained from a variety of sawmills and planing mills.

*Information*

Lignum



**Profile Boards**

DIN 4072 (matched boards)  
DIN 68122 (matched fibreboards)  
DIN 68123 (weatherboards)  
DIN 68126-1 +3 (profile boards with broad root and chamfer)

*Dimensions*

Matched boards:  
Thickness (European) [mm]:  
15.5, 19.5, 22.5, 35.5  
Width [mm]: 95, 115, 135, 155  
Thickness (northern) [mm]:  
19.5, 22.5, 25.5  
Width [mm]: 96, 111, 121

Matched fibreboards:  
Thickness (European) [mm]:  
15.5, 19.5  
Width [mm]: 95, 115  
Thickness (northern) [mm]:  
12.5  
Width [mm]: 96, 111

Weatherboards:  
Thickness (European) [mm]:  
19.5  
Width [mm]: 115, 135, 155  
Thickness (northern) [mm]:  
19.5  
Width [mm]: 111, 121, 146

Profile boards with broad root and chamfer:  
Thickness (European) [mm]:  
12.5, 15.5, 19.5  
Width [mm]: 96, 115  
Thickness (northern) [mm]:  
12.5, 14, 19.5  
Width [mm]: 12.5, 14, 19.5

Length (European) [mm]:  
1,500-4,500, gradations 250 (increments)  
1,500-6,000, gradations 500  
Length (northern) [mm]:  
1,800-6,000, gradations 300

*Material*

Matched boards are boards with grooves and planed tongues.

Softwood matched boards are boards with planed tongues and grooves, chamfered to an angle of less than 45° on the upper side.

Softwood weatherboards are boards with planed tongues and grooves, and a concave-rounded edge on the tongue side.

Softwood profile boards with broad root and chamfer are boards with tongues, planed grooves and chamfered edges on the visible face and a wide tongue on the face side.

*Use*

Matched and profile boards are used to panel both interiors and exteriors. Any building boards that have to be dimensioned in relation to their load-bearing capacity must meet the requirements of DIN 1052 and be graded in accordance with DIN 4074-1.

For invitations to tender and orders:

- Designation -DIN
  - Grade
  - Wood species
  - Thickness
  - Width
  - Length
- Calculated per  $m^2$

*Manufacture*

Planed and profile woods are sawn from round timber in sawmills and then milled and planed in planing mills.

In addition to the forms and dimensions covered by DIN, other profiles and dimensions can be obtained from the manufacturer - depending on the tools and equipment at the manufacturer's disposal. Planing mills make profile boards on request and sell them through trade stores.

*Manufacturers/(selection)*

The assortment of profile boards available from trade stores varies considerably due to the great range of types and shapes.

*Information*

Bundesverband Deutscher Holzhandel e.V.



### Blockboard and laminated board

DIN 68705-2  
Thermal conductivity:  
 $\lambda_s = 0.15 \text{ W/mK}$   
Vapour diffusion resistance factor:  
 $H = 50/400$   
Raw density:  
 $\rho = 400\text{-}800 \text{ kg/m}^3$   
Computation weight in accordance with DIN 1055-1:  
 $4.5\text{-}6.5 \text{ kN/m}^3$   
Building material classification:  
B2  
Material class:  
20, 100  
Emission class:  
E1  
Wood moisture content:  
 $5 < 15\%$   
Amount of swelling and shrinkage per % change in wood moisture content:  
0.020 %

#### Wood species:

- spruce
- fir
- pine

#### Dimensions

Thickness [mm]:  
13, 16, 19, 22, 25, 28, 30, 38  
Length [mm]:  
1,220, 1,530, 1,830, 2,050, 2,500, 4,100  
Width [mm]:  
2,440, 2,500, 3,500, 5,100, 5,200, 5,400

#### Material

Formerly known as core plywood, blockboard consists of a core layer of solid wood board-shaped strips that are glued together. The width of the strips varies from approx. 24 mm to a maximum of 30 mm. A face veneer (three-ply board) or a cross-band veneer and a face veneer (five-ply board) is fixed to each side, with the grain running perpendicular to that of the adjacent layer.

Laminated boards are composed of a middle core of perpendicular rotary-cut veneers (strips) that are glued together. The veneers are 5-8 mm thick. A face veneer, or a cross-band veneer and a face veneer, are fixed to each side. The grain of each sheet runs perpendicular to that of the adjacent one.

All glues with an assured adhesive strength are permissible.

In the case of blockboard, the glued wooden core is composed of softwoods (primarily spruce) to ensure a more stable form, whereas softer or harder hardwoods are generally chosen for cross-band veneers and face veneers.

The same wood species can be used for both wooden core and veneer plywood, alongside the customary indigenous softwoods and hardwoods. A number of tropical woods are also used for the cores and for cross-band and face veneers, rounding off the customary indigenous softwoods and hardwoods available.

#### Use

Blockboards and laminated boards are primarily used in the manufacture of furniture, as well as in laboratory and stair construction. However, they are rarely used in timber engineering.

For invitations to tender and orders:

- Manufacturer
- DIN
- Panel type
- Wood species
- Emission class
- Thickness
- Width
- Length
- Surface

Calculated by  $m^2$

#### Manufacture

In general, 24 mm-thick softwood boards that have been carefully dried to a wood moisture content of approx. 6-8 per cent are considered suitable for the manufacture of block cores. These boards are cut into laths with multi-blade circular saws so that the lath width corresponds to the thickness of the inner core. The laths are then glued together with casein, polyvinylacetate or urea-formaldehyde resins to form boards and pressed.

DIN 68705-4 refers to structural blockboard and core-stripe blockboard as plywoods with defined, monitored elasto-mechanical properties. They are used in building construction (e.g. for reinforcement).

In the manufacture of the core, rotary cut veneers 5-8 mm thick are glued in layers parallel to the grain to create blocks. These are then sawn at right angles to the level of the single plies to make boards. In both manufacturing processes, the cross-band and face veneers are glued to the inner plies with the same glues and pressed.

Manufactures) (selection)  
Pfleiderer



### Three- and Five-Ply Panels

German building authority certification:

Z-9.1-242  
Z-9.1-258  
Z-9.1-376  
Z-9.1-404  
Z-9.1-477

Thermal conductivity:

$\lambda_{10} = 0.14 \text{ W/mK}$

Vapour diffusion resistance factor:

$11=50/400$

Raw density:

$\rho = 400\text{-}500 \text{ kg/m}^3$

Building material classification:

B2

Material class:

20, 100, 100G

Emission class:

E1

Wood moisture content:

$12 \pm 2 \%$

Amount of swelling and shrinkage

per % change in wood moisture

content:

0.020 %

Wood species:

\* spruce

\* larch

\* Douglas fir

#### Dimensions

Thickness (three-ply) [mm]:

12-75

Thickness (five-ply) [mm]:

33-80

[Length] [mm]:

2,500-6,000

Width [mm]:

1,000-4,750

Invitations to tender and orders:

- Manufacturer
- Certification number
- Panel type
- Wood species
- Wood preservation measures
- Thickness
- Width
- Length
- Surface

Calculated per  $m^2$

#### Manufacture

In the case of softwood plies glued at right angles to one another, at least 90 per cent of the single sheets must be grade S10 (DIN 4074-1) and the remaining sheets at least grade S7.

The surface veneers must be at least 4-9 mm thick, and those of the inner plies 4-50 mm.

#### Material

The panels consist of three or five layers of softwood, each glued at right angles to the adjacent ply. Melamine modified urea-formaldehyde and phenolic resin are used as glues.

Since the thicknesses of the single plies vary according to type and manufacturer, the elasto-mechanical properties of panels of equal thickness can also differ considerably.

#### Applications

Depending on glue type and the wood preservative (if any), the panels can be employed wherever panels of wood classes 20, 100 and 100 G are allowed under both the German Building Regulations and DIN 68800-2.

Once permission has been granted, the multi-ply panels can be used as effective and as reinforcing planking in manufacturing wall, ceiling and roof panels for wooden houses that are erected as panel construction systems in accordance with DIN 1052-3.

Depending on the type of permit granted, these panels can sometimes be used in place of laminated construction board as per DIN 1052-1.

If the edges are carefully covered or sealed for protection, they can also be used for large ventilated facades.

#### Manufacturer(s) (selection)

Dold Süddeutsche Sperrholzwerke  
Gmach Holzbauwerke  
Haas Fertigbau GmbH  
Kaufmann Holzbauwerk  
Probstel Holzwerke



Laminated Construction Board

DIN 68705-3  
German building authority certification:  
Z-9.1-43  
Z-9.1-6  
Z-9.1-7  
Thermal conductivity:  
 $\lambda_{\parallel} = 0.15 \text{ W/mK}$   
Vapour diffusion resistance factor:  
 $\mu = 50/400$   
Raw density:  
 $\rho = 450-800 \text{ kg/rrf}$   
Building material classification:  
B2  
Wood moisture content:  
5-15 %  
Amount of swelling and shrinkage  
per % change in wood moisture content:  
Thickness: 0.25-0.35 %  
Length/width: 0.01-0.02 %

Wood species (selection):

- spruce
- pine
- Clear pine
- Douglas fir
- Hemlock
- Soutlwn pine
- mahogany
- Cherry mahogany

Panel types;

Laminated construction board 20  
Laminated construction board 100  
Laminated construction board 100 G

Dimensions

Thickness [mm]:  
8, 9, 10, 12, 15, 18, 20, 21, 24, 25, 40  
Formats [mm]:  
2,500/3,000x1,250/1,500  
2,400/3,050 x 1,200/1,525

Material

Laminated construction board is made by arranging and gluing alternate veneers perpendicular to one another. Urea resin is used to glue the veneers of laminated construction board 20, whereas water-resistant, alkaline hardening / phenolic resin, phenol-formaldehyde resin, and resoreino! resin are used for laminated construction board 100 and 100 G. All other glues must be certified by the building authorities.

Application(s)

Laminated construction board is mostly used as effective, reinforcing panelling for walls, ceilings and roofs, For the required panel type, which depends on the panel's position in the building component, please refer to DIN 68800-2.

Panel type	Panel moisture in service
Laminated construction board 20	k 15 %
Laminated construction board 100	<. 18 %
Laminated construction board 100Gk	21 %

Manufacture

Laminated construction board is made from the same wood species as normal plywood. However, light species of tropical wood such as limba and obeche may not be used.

Beech laminated construction board, as per DIN 68705-5, consists of three to nine veneers, each 1.5-3.2 mm thick (from wood classes 100 and 100 G). It is used, in particular, for building elements subjected to great static loads.

Beech laminated construction board (100 G) panels are either made of sap-clear wood corresponding to at least resistance class 2 as specified in DIN 68364 (e.g. oak, mahogany, cherry mahogany) or from another wood species

Invitations to tender and orders:

- Laminated construction board
  - DIN 68705
  - Certification number
  - Panel type
  - Emission class
  - Thickness, width, length
  - Surface finish
- Calculated by  $\text{m}^3$

bonded with a glue liquor to which a wood preservative has been added. If a chemical wood preservative is required because the species used has a low resistance class, a wood preservative designed to eliminate destructive fungi (basidiomycetes) must be added to the glue liquor when the panels are being manufactured.

The panels must bear the following permanent identification:

- Kite mark
- DIN certification number
- External quality control stamp
- Panel type
- Emission class
- Thickness

Manufacturer(s)(selection)

Blomberger Holzindustrie  
Bruynzeel Multipanel GmbH  
Dold Suddeutsche Sperrholzwerke  
Finnforest Oy  
Glunz AG  
Hess & Co. AGT  
ROHOL Rosenauer  
R.O.L. Rougier Ocean Landex  
Schaumann Wood Oy  
Teuteburger Sperrholzwerk  
Westag & Getalit AG

Information

American Plywood Ass. (APA)  
Cofi Canadian Plywood Association  
Council of Forest Industries of British Columbia  
Finnish Plywood International  
Güteschutzgemeinschaft Sperrholz e.V.  
Lignum  
Proholz  
Verband der Deutschen Holzwerkstoffindustrie e.V.

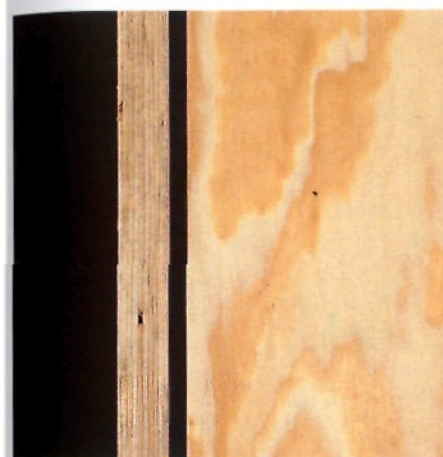

Parallel Laminated Veneer

German building authority certification:  
Z-9.M00  
Z-9.1-291  
Z-9.1-245  
Thermal conductivity:  
 $\lambda_{\parallel} = 0.15 \text{ W/mK}$   
Vapour diffusion resistance factor:  
 $\mu (1 = 50/400)$   
feaw density:  
•  $\rho = 400-800 \text{ kg/m}^3$   
Building material classification:  
B2  
Emission class:  
E 1  
Wood species:  
\* spruce  
\* pine (kerto)  
\* Douglas fir  
\* Southern pine (microlam)

Dimensions:

Kerto-S veneers are used for load-bearing, rod-shaped structural members.  
thickness [mm]:  
21-69  
lax. dimensions [mm]:  
1.820x23,000  
Kerto-Q veneers are used for panels and plates.  
 $h \leq 1,800$   
thickness [mm]:  
21-75  
Max. sizes [mm]:  
(1.820x23,000

Invitations to tender and orders:

- Manufacturer
  - Certification number
  - Type of parallel laminated veneer
  - Thickness, width, length
  - Wood preservation measures
- Calculated by  $\text{m}^3$

Manufacture

In the manufacture of parallel laminated veneer, softwood logs are de-barked, soaked in water and stripped to make 3 mm-thick veneers, which are then cut into dimensioned sheets and dried. Large defective areas are removed, as are veneers that are too light, moist or misshapen. The veneers, which are provided with staggered joints, are then glued with phenol-formaldehyde resin parallel to the grain, placed on top of one another and pressed to form a panel. The large panels thus created can be sawn to the desired panel or beam size.

Material

Parallel laminated veneer is a multi-ply wood-based material. In contrast to plywood, its veneers are generally arranged parallel to the grain and glued watertight with phenol-formaldehyde resin. If broad widths are required, plies are also arranged crosswise to increase stability. When wood class 100 G veneers are glued together, the single sheets are impregnated with a wood preservative to for protection against destructive fungi.

Application(s)

Parallel laminated veneer may be used in all areas of work in which glued laminated timber is permitted. Owing to the high loads it is permitted to bear, parallel laminated veneer can also be used for reinforcing the following structural elements:  
purlins and other girders subject to bending, girders at the point of support, load-bearing plates, connecting plates, etc.

The presence of cup shakes in the veneers makes it relatively easy to impregnate parallel laminated veneer with aqueous wood preservatives across its entire cross-sectional area. As a result, it can be used in areas exposed to the weather (e.g. external use for roof panels).

Manufacturers)(selection)

Merk Holzbau GmbH  
Finnforest OY  
Trus Joist Mac Millan



**Parallel Strand Lumber**

German building authority certification:  
Z-9.1-241  
Thermal conductivity:  
 $A_H = 0.15 \text{ W/mK}$   
Vapour diffusion resistance factor:  
 $M = 50/400$   
Raw density:  
 $\rho = 670 \text{ kg/m}^3$  for Douglas fir  
 $\rho = 720 \text{ kg/m}^3$  for southern yellow pine  
Building material classification:  
B2  
Material class:  
100, 100G  
Wood species:  
• Douglas fir  
• Southern pine

**Material**  
Parallel Strand Lumber (PSL) consists of strands approximately 16-mm wide and 3.2 mm thick. These are aligned parallel to the longitudinal axis of the beam and glued with waterproof phenol-formaldehyde resin. The graded strands are glued to create 483 mm-thick panels and then sawn into beams.  
Currently, PSL is only manufactured in the USA.  
Paraffin is applied to give the lumber a water-repellent finish.  
Owing to the natural resistance of the two wood species used (resistance class 3 in accordance with DIN 68364), no wood preservatives are added.

**Application(s)**  
Parallel Strand Lumber can be used for all work in which glued laminated timber is permitted unless otherwise certified. Parallel Strand Lumber has material properties very similar to those of glued laminated timber; its advantages lie in its considerable flexural, compression and shearing strengths.  
The adhesive bond is weather resistant, but weather exposure causes the wood to turn grey.

**Dimensions:**  
Width [mm]:  
44-280  
Height [mm]:  
44-483  
Length [m]:  
up to 20

Invitations to tender and orders:  
• Certification number  
• Wood species  
• Thickness  
• Width  
• Length  
Calculated by m<sup>3</sup>

**Manufacture**  
After being soaked and steamed, the logs are peeled to create veneers 2.5-3.2 mm thick. The strands are then dried to obtain a 9-10 percent moisture content and cut into 45-260 cm-long strips. After the defects have been extracted, the strands are glued with phenol-formaldehyde resin and pressed in continuously operating press. Afterward, they are cured in a microwave process.  
The veneer strands are arranged parallel to one another with their ends staggered. During the pressing process, the material is compressed to increase its raw density to a value slightly higher (approx. 15 percent) than that of the original wood. As there are gaps between the strands, cavities are visible, especially at the ends. The resulting 20 m-long section is then cut to the desired lengths.

**Manufacturers)(selection)**  
Merk Holzbau GmbH  
Trus Joist Mac Millan



**Laminated Strand Lumber**

German building authority certification:  
Z 9.1-323  
Thermal conductivity:  
 $\Lambda = 0.14 \text{ W/mK}$   
Vapour diffusion resistance factor:  
 $u = 50/400$   
Raw density:  
 $\rho = 600-700 \text{ kg/m}^3$   
Building material classification:  
B2  
Material class:  
100  
Emission class:  
E1  
Wood moisture content:  
15%  
Wood species:  
poplar  
Glues:  
Polyurethane adhesive

**Application(s)**  
Laminated Strand Lumber may be used for all areas of work in which glued laminated timber is permitted in accordance with DIN 1052-1 and in which laminated construction board is permitted in accordance with DIN 68705-3. The wood is preserved in the same way as glued laminated timber.

**Dimensions:**  
Thickness [mm]:  
32-89  
Format [mm]:  
max. 2,438 x 10,700

Invitations to tender and orders:  
• Manufacturer  
• Certification number  
• Panel type  
• Wood species  
• Gluing  
• Emission class  
• Thickness  
• Width  
• Length  
Calculated by m<sup>3</sup>

**Manufacture**  
Laminated Strand Lumber consists of approx. 1.0 x 25 x 300 mm-long poplar chips which are glued together with formaldehyde-free polyurethane resin (PMDI).  
After being bonded in a mixer, the chips are aligned in their original grain flow. The mass is pressed under heat and then separated and ground.  
Long-chip wood is manufactured in two grades: Inratlam S and Intrallam P.

**Manufacturers)(selection)**  
Trus Joist MacMillan



### Oriented Strand Board (OSB)

DIN EN 300  
German building authority certification:  
2-9.1-275  
Z-9.1-326  
Thermal conductivity:  
 $\lambda_R = 0.13 \text{ W/mK}$   
Vapour diffusion resistance factor:  
 $H = 50/100$   
Raw density (depending on wood species):  
 $\rho = 600-660 \text{ kg/m}^3$   
Computation weight in accordance with 1055-1:  
 $5-7.5 \text{ kN/m}^5$   
Building material classification:  
B2  
Material class:  
100  
Emission class:  
E1  
Wood moisture content:  
5-6%  
Amount of swelling and shrinkage per % wood moisture content:  
0.035 %

Wood species:  
• pine  
• Clear pine  
• Douglas fir  
• Oregon pine  
• alder  
• poplar

*Dimensions*  
Thickness [mm]:  
6, 8, 9, 10, 11, 12, 13, 15, 18, 22, 25, 30  
Formats [mm]:  
2,500/5,000x1,250  
5,000 x 2,500  
2,440x1,220  
2,620 x 1,250/5.000

invitations to tender and orders:

- Manufacturer
  - Certification number
  - Panel type
  - Emission class
  - Thickness, Width, Length
  - Surface
- Calculated by  $m^2$

### Manufacture

Large coarse rectangular chips (ca. 35 x 75 mm, thickness 0.6 mm) are used to manufacture OSB boards. The flat chips are obtained by peeling and crushing veneers or by using a chipper. They are then sieved, graded, dried, glued, spread out and aligned. The strands are arranged crosswise in three or five layers, depending on the required board thickness. In the case of three-ply boards, the core (comprising 50 per cent of the whole) is generally laid crosswise, whilst the grain of the surface sheets (accounting for 25 per cent each) generally runs parallel to the machined length. Once the strands have been aligned, the sheets are pressed under heat. After they have cooled, they are formatted and ground.

### Material

OSB (oriented strand board) is composed of aligned strands. Owing to the alternating, cross-alignment of the strands, oriented strand boards - like plywood - have mechanical properties. Excellent mechanical properties have been obtained (two to three times those of normal chipboard types) by machine-cutting the wood parallel to the grain.

A variety of glues is used for bonding: phenol resin, polycarbamide (isocyanate), MUPF (Kauramin) surface glue, and PMDI core resins. All these resins are waterproof.

### Application(s)

Typical areas of application:  
OSB flat-pressed boards may be used for all work where class 100 wood-based materials are permitted under the local Building Regulations.  
It may be used for panelling, with weather proofing, the exterior of load-bearing/reinforcing walls.

### Manufacturers(selection)

CSC Forest Products (Sterling) Ltd.  
Glunz AG  
Kronospan Ltd.&Cie.

### Information

Verband der Deutschen  
Holzwerkstoffindustrie (VHI)



### Fibreboard

DIN 68754-1  
Thermal conductivity:  
 $\lambda = 0.065-0.17 \text{ W/mK}$   
Vapour diffusion resistance factor:  
 $H = 5-70$   
Raw density:  
 $\rho = 350-1100 \text{ kg/m}^3$   
Computation weight in accordance with DIN 1055-1:  
 $9-11 \text{ kN/m}^5$   
Building material classification:  
B2  
Material class:  
20 (100 with certification)  
Emission class:  
E1  
Wood moisture content:  
 $5 \pm 3 \%$   
Amount of swelling and shrinkage per % change in wood moisture content:  
 $< 20 \%$  in thickness

### Wood species:

- spruce
- pine
- fir
- beech
- poplar
- birch

### Glues:

- Urea-formaldehyde resins
- Phenol-formaldehyde resin

### Dimensions:

Thickness [mm]:  
• 5-16  
[Width [mm]:  
up to 2,100  
Length [mm]:  
up to 5,500

Invitations to tender and orders:

- Manufacturer
  - DIN
  - Certification number
  - Panel type
  - Gluing
  - Emission class
  - Thickness
  - Width
  - Length
- Calculated by  $rrf$

### Manufacture

In the manufacture of wood fibreboards, the wood chips are placed in a reaction tank known as a defibrator, steam-treated and then defibrated mechanically with grinding plates. This approach primarily exploits the matting properties of the fibres and their natural adhesive strength. The latter can be increased by adding bonding agents and water-repellents as well as by thermal and other treatments. The various manufacturing processes differ mainly in the technique employed to produce the fibrous material and the fibrous mat. These processes are referred to as wet or dry processes, depending on whether the fibrous material is transported or formed in a wet or dry process.

### Material

Fibreboards are panel-shaped materials made of fibrous - primarily wood - particles. The particles are combined under heat, with or without glue or additives. Pressure may be applied. Fibreboards can be manufactured as single- or multi-ply boards in a wet process without bonding agents or in a dry process using bonding agents. Depending on their raw density they are subclassified as:  
• Porous fibreboards, not bituminated  
- Bituminated porous fibreboards  
- Hardboard and medium-density wood fibreboards for the construction industry  
• for interiors and furniture  
Other types of wood fibreboard are also available, e.g. medium-density fibreboards.

Soft fibreboard: see insulating materials.

### Application®

According to DIN 1052-3, the use of fibreboards as effective and reinforcing boards in the manufacture of wall, ceiling and roof panels is restricted to wooden houses built as panel construction systems.

They may also be used in rooms with a low moisture content, i.e. in areas where wood class 20 is used and in areas in which wood class 100 is permitted by the local Building Authority.

### Manufacturer(s)(selection)

Euro MDF Board  
Gutex  
Hornitex  
Kunz GmbH & Co  
Odenwald Faserplattenwerk  
Pavatex  
Wilhelmi Werke GmbH & Co KG

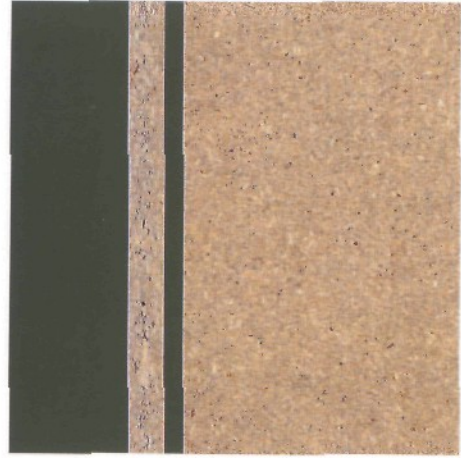

### Flat-Pressed Boards (FP)

DIN 68763  
Thermal conductivity:  
 $\lambda_H = 0.13 \text{ W/mK}$   
Vapour diffusion resistance factor:  
 $\mu = 50/100$   
Raw density:  
 $\rho = 550-700 \text{ kg/m}^3$   
Computation weight in accordance with  
DIN 1055-1;  
 $5-7.5 \text{ kN/m}^3$   
Building material classification:  
B2  
Material class:  
20, 100, 100 G  
Emission class:  
E1  
Wood moisture content:  
 $5 < 12 \%$   
Amount of swelling and shrinkage  
per % change in wood moisture content:  
0.035 %

Wood species:  
• Softwood  
• Hardwood

Glues:  
• Urea-formaldehyde resins  
• Melamine modified urea-formaldehyde  
• Phenol resin  
• PMDI

#### Dimensions

Thickness [mm]:  
4, 8, 10, 13, 16, 19, 22, 25, 28, 38  
Formats [mm]:  
1,250 x 2,500, 1,250 x 5,000,  
4,100 x 1,850, 2,710 x 2,080,  
2,750/5,300 x 2,050  
Lengths of up to 14,000mm are available

#### Material

Flat-pressed boards are panel-shaped wood-based materials that are made by bonding and pressing particles of wood or wood-like fibrous materials. Depending on the gluing procedure and wood preservatives, the panel types can be classified as follows:

#### - V20

This resin is only suitable for rooms where humidity is generally low, as it is not resistant to atmospheric corrosion. Glues: aminoplasts, alkaline-hardened phenolic resins, polymeric diphenyl methylene diisocyanate (PMDI).

#### • V100

For use in humid rooms. Glues: alkaline-hardened phenolic resins, phenol-resorcinol resins, PMDI.

#### • V100G

Also durable in highly humid environments; protected against destructive fungi by a wood preservative. Glues: alkaline-hardened phenol resorcinol resins, PMDI.

#### Application®

Flat-pressed boards manufactured for the construction industry are primarily used as effective, reinforcing panelling for walls, floors, ceilings and roofs. Panel selection depends on the intended use in these building elements. Information may be found in DIN 68800-2 (see appendix).

#### Invitations to tender and orders:

- Manufacturer
- DIN 68763
- Panel type
- Gluing
- Emission class
- Thickness
- Width
- Length

Calculated by  $\text{m}^2$

#### Manufacture

Flat-pressed boards are manufactured by bonding and pressing relatively small wood chips, which are ideally aligned parallel to the board surface. These boards are generally manufactured as homogenous multi-ply panels.

#### Manufacturer(s)(selection)

Glunz AG  
Hornitex  
Kunz GmbH  
Pfleiderer Industrie  
Schlingmann GmbH & Co.

#### Information

Verband der Deutsche  
Holzwerkstoffindustrie e.V.



### Extruded Particle Boards

DIN 68764-1/2  
Thermal conductivity:  
 $\lambda = 0.17 \text{ W/mK}$   
Vapour diffusion resistance factor:  
 $\mu = 20$   
Raw density:  
 $\rho = 450-700 \text{ kg/m}^3$   
Computation weight in accordance with  
1055-1:  
 $5-7.5 \text{ kN/m}^3$   
Building material classification:  
B2  
Emission class:  
E1  
Wood moisture content:  
 $5 < 12 \%$

#### Wood species:

- spruce
- fir
- pine

#### Glues:

- Urea-formaldehyde resin
- Melamine modified urea-formaldehyde
- Phenol resin
- PMDI

#### Dimensions

Thickness [mm]:  
• Solid extruded board: 10-34  
• Tubeboards [mm]: 23-80  
Width [mm]:  
1 900-2,100  
Length [mm]:  
up to 5,000

#### Invitations to tender and orders:

- Manufacturer
- DIN
- Panel type
- Wood species
- Gluing
- Emission class
- Thickness
- Width
- Length

Calculated by  $\text{m}^2$

#### Manufacture

In the manufacture of extruded particle boards, particles are mixed with a bonding agent and pushed rhythmically along a heated channel by a ram. The cross-section of the channel forming the board corresponds to that of the resulting product. The particles are positioned perpendicularly to the board's surface, which produces a relatively high shearing strength at right angles to the surface. Extruded particle boards are made in a continuous manufacturing process because the heating process and the rate of feed are adjusted to the curing time. As the particles pass through the channel shaft, they are bonded together to form an endless stream of board that is only cut into sections after pressing is completed.

Solid extruded boards are produced in single layers only. Owing to the arrangement of the particles, these boards have a lower flexural strength than flat-pressed boards. Extruded particle boards are only suitable as cores in composite boards, Tubeboards, whose cores contain tubular cavities, are produced by arranging tubes parallel to the shaft.

#### Manufacturers(selection)

Sauerländer Spanplatten GmbH & Co. KG





### Fibre-Reinforced Cement Boards

- DIN EN 633**  
**DIN EN 634**  
 Thermal conductivity:  
 $\lambda_{\text{m}} = 0.35 \text{ W/mK}$   
 Vapour diffusion resistance factor:  
 $\mu = 20/50$   
 Raw density:  
 $\rho = 1,250-1,300 \text{ kg/m}^3$   
 Building material classification:  
 B 1, A 2  
 Material class:  
 20, 100, 100 G  
 Emission class:  
 E 1  
 Wood moisture content:  
 $9 \pm 3 \%$   
 Amount of swelling and shrinkage  
 per % change wood moisture content:  
 0.03%
- Wood species:  
 • spruce  
 • fir
- Bonding agent:  
 • Cement

### Material

In contrast to organically bonded wood-based materials, fibre-reinforced cement boards are anorganically bonded with cement (which accounts for approximately one third of their weight percentage). They can be used in the same fields as wood classes 20, 100, 100G in accordance with DIN 68800-2. The bonding agent renders the boards moisture-resistant. The boards can be coated and plastered for more effective and enduring weather protection. They are certified for use as load-bearing and reinforcing panels for wooden panel-construction houses under DIN 1052-3.

The panels are hardly flammable and have been classified as B1 under DIN 4102. To ensure that they meet the requirements of building material classification A 2 (not flammable), perlite (amounting to approx. 24 % of total mass) is added.

### Application(s)

Fibre-reinforced cement boards are used as exterior wall cladding or as wall-reinforcement panelling. Effective, enduring weather protection is essential for exterior walls. Their good fire-proofing properties make these panels suitable as fire barriers. They also have good sound-insulating properties owing to their high raw density, and can be used as a floor covering.

### Dimensions

- Thickness [mm]:  
 8-40  
 Format [mm]:  
 1.250x2.600, 1.250x3.100

### Invitations to tender and orders:

- Manufacturer
  - DIN
  - Certification number
  - Panel type
  - Emission class
  - Thickness
  - Width
  - Length
  - Surface
- Calculated by rrf

### Manufacture

Coniferous wood (spruce or fir) that has been stored for three to four months and not treated against fungi is chipped and separated into fine and coarse chips and then stored in chip bins. A mixture of wood chips, cement, recycled trimmings, supplementary agents and water is prepared in a semi-dry process in a mechanical mixer. The material is evenly separated into an outer layer and a core layer in a mechanical sifter and spread evenly across plates. Surplus material is fed straight back into the mixer. There is no waste water. The mix is pressed and allowed to set in a climatic chamber. Afterwards, the boards are cured for approximately four weeks in a conditioning storage unit. Prior to shipment, the panels are conditioned so that they have the right moisture balance; they are then trimmed and cut, and their edges profiled. Finally, they are impregnated and coated.

### Manufacturer(s)(selection)

- Eternit AG  
 Fulgurit  
 Glunz AG

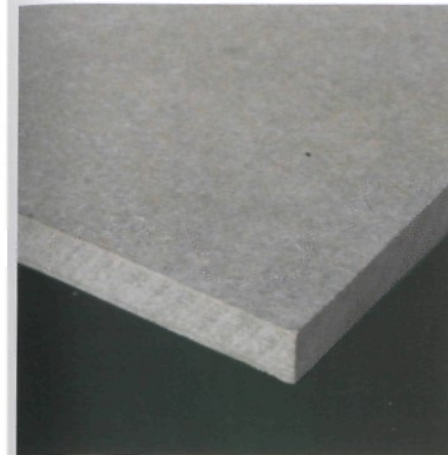

### Fibre Cement Boards

- German building authority certification:  
 Z-31.1-34  
 Z-31.1-36  
 Thermal conductivity:  
 $\lambda_{\text{m}} = 0.58 \text{ W/mK}$   
 Vapour diffusion resistance factor:  
**H-11**  
 Raw density:  
 $\rho = 1,150-2,000 \text{ kg/m}^3$   
 Building material classification:  
 A 2

### Material

Fibre cement is a composite material of fibre and cement. It consists of 40 % Portland cement, 11 % aggregate (limestone powder), 2 % reinforcement fibre, and 5 % cellulose fibres and water.

### Application

Fibre cement boards are suitable as weatherproofing for roofs and walls, and may also be used as ventilated exterior wall cladding as per DIN 18516-1.

### Invitations to tender and orders:

- Manufacturer
  - Certification number
  - Thickness
  - Width
  - Length
  - Surface area
- Calculated per m<sup>2</sup>

### Production

Fibre cement boards are made of an intimate mixture of cement and water plus artificial and cellulose fibres. They are manufactured with a surface coating or with various colour additives. The inorganic materials are weatherproof, frost- and rot-resistant, and incombustible. In addition, they are largely resistant to aggressive chemical atmospheres. In the mixture, the fibres perform a similar function to that of steel in reinforced concrete.

### Manufacturer(s)(selection)

- Eternit AG  
 Fulgurit Baustoffe GmbH  
 Wanit

### Information

Fachregeln des Deutschen Dachdeckerhandwerks (Professional Regulations of the Germany Roofing Trade Deutsches Dachdeckerhandwerk)



### Plasterboard

DIN 18180  
 German building authority certification:  
 Z-9.1-199  
 Z-9.1-204  
 Z-9.1-221  
 Z-9.1-246  
 Z-9.1-318  
 Z-9.1-319  
 Thermal conductivity:  
 $\lambda_r = 0.21 \text{ W/mK}$   
 Coefficient of thermal expansion:  
 $0.013\text{-}0.020 \text{ mm/mK}$   
 Vapour diffusion resistance factor:  
 $H = 8$   
 Raw density:  
 $\rho = 900\text{-}1000 \text{ kg/m}^3$   
 Building material classification:  
 A2  
 Heat storage capacity:  
 $C = 960 \text{ J/kgK}$

**Dimensions:**  
 Thickness [mm]:  
 9.5, 12.5, 15, 18, 20, 25  
 Width [mm]:  
 600, 625, 1,250  
 Length [mm]:  
 2,000-4,000 in  
 increments of 250

### Material

Plasterboard consists of a plaster core encased in adhesive cardboard. Natural and FGB plaster obtained from flue gas desulfurisation provide the raw materials for production.  
 Depending on the application, various types of plasterboard may be used, with different cardboard casings and plaster additives:

- Gypsum plasterboard  
 Yellowish-white cardboard, blue lettering
- Fire protection plasterboard  
 Yellowish white cardboard, red lettering
- Impregnated plasterboard  
 Greenish cardboard, blue lettering
- Impregnated fire protection plasterboard  
 Greenish cardboard, red lettering
- Gypsum baseboard  
 Grey cardboard, blue lettering
- Gypsum dry screed board  
 with/without sound-impact insulation

### Applications

Plasterboard can serve as wall or ceiling panelling, as a lining for suspended ceilings, as lining for prefabricated walls, and as dry screed.

It may be used wherever class 20 wooden boards are allowed as per DIN 68800-2. In addition, impregnated plasterboard may be installed on the outside of exterior wall elements if the conditions for effective, lasting weather protection, as specified in the note of authorization, are met.

Plasterboard may be used as reinforcing panelling for ceilings in wooden buildings (fixed to the bottom side) and for pitched roofs.

Plasterboard may also be employed as a load-bearing reinforcement for wall panelling in wooden houses erected as panel construction systems.

### Invitations to tender and orders:

- Board type
  - Thickness
  - Length
  - Width
  - Edge shape
- Calculated per rrf

### Production

Plasterboard is produced on large conveyor belts in a continuous manufacturing process. The calcined, ground plaster is mixed with water and additives, sprayed onto a base, and formed into boards together with the cardboard lining. The boards are then lettered, cut, turned, dried and bundled.

In combination with the plaster core, the cardboard reinforces the tensile zone and lends the boards the requisite firmness and flexural strength.

### Manufacturer(s)(selection)

Danogips GmbH  
 Fels-Werke GmbH  
 Gebr. Knauf Westdeutsche Gipswerke  
 Gyproc GmbH  
 Lafarge Gips GmbH  
 Lindner AG  
 Fiigips GmbH

### Information

Industriegruppe Gipsplatten



### Gypsum Fibreboard

German building authority certification:  
 Z-9.1-187  
 Z-PA-III 4.864  
 Thermal conductivity:  
 $\lambda = 0.36 \text{ W/mK}$   
 Vapour diffusion resistance factor:  
 $H = 11$   
 Raw density:  
 $\rho = 880\text{-}1,250 \text{ kg/m}^3$   
 Building material classification:  
 A2

**Dimensions:**  
 Thickness [mm]:  
 10, 12.5, 15, 18  
 Sizes [mm]:  
 1,000 x 1,500  
 1,245x2,000  
 1,245x2,500  
 1,245x2,540  
 1,245x2,750  
 1,245x3,000

### Material

Gypsum fibreboard is a homogenous board made of a mixture of calcined natural plaster and cellulose fibres. The cellulose fibres, which are primarily obtained from recycled paper, strengthen the board.

### Application<sup>^</sup>)

Gypsum fibreboard can serve as wall or ceiling panelling, as a lining for suspended ceilings and prefabricated walls, and as dry screed (when used in multiple layers). In the form of composite board with foam plastic, it can be used to provide additional thermal insulation. Gypsum fibreboard may be used as a load-bearing reinforcement for wall panels in both wooden houses with a panel design and in timber skeleton buildings. It may be employed as reinforcing and load-bearing wall panelling wherever class 20 wood material is permitted (in accordance with the German building authority certification). It may also be used to plank the outside of exterior wall elements if effective, lasting weatherproofing is ensured.

Gypsum fibreboard is resistant to fire and humidity.

### For requests for tenders and orders

- Gypsum, fibreboard
  - Certification number
  - Thickness, length and width
- Calculated per m<sup>2</sup>

### Production

Cellulose fibre is obtained from paper in a recycling process and then mixed with ground plaster. Water is added to the mixture, with no additional bonding agent. The mix is pressed into boards under high pressure, dried, impregnated with a water-repellent agent and formatted.

### Manufacturer(s)(selection)

Fels-Werke  
 Lindner AG  
 Rigips GmbH



For invitations to tender and orders:

- Manufacturer
- DIN
- Application type
- Thickness
- Width
- Length

Calculated per m<sup>2</sup>



For invitations to tender and orders:

- Manufacturer
- DIN
- Application type
- Thickness
- Width
- Length

Calculated per m<sup>2</sup>

### Wood Fibre

DIN 68755

DIN EN 316

Thermal conductivity:

$\lambda_B = 0.045-0.060 \text{ W/mK}$

Vapour diffusion resistance factor:

$\mu = 5-10$

Raw density:

$\rho = 130-450 \text{ kg/m}^3$

Building material classification:

B2

Thermal capacity:

$C = 360 \text{ kJ/m}^2\text{K}$

Application types:

T, TV, IC

### Material

Porous soft fibreboard is manufactured from spruce, fir and pine pulp in a wet production process. Fibre humidity exceeds 20 per cent during the manufacturing process.

The raw density of soft fibreboard lies below  $450 \text{ kg/m}^3$ , making it lower than that of medium hard and hard fibreboard.

### Application@

Soft fibreboards are used as insulation for floors, walls, ceilings and roofs; they are also employed as impact sound insulation under floor screed, dry screed and wood flooring, and as sound absorbing panels.

Depending on the application, the boards are connected by butt joints, rebate joints or tongue-and-groove joints. The panels are loosely laid and then mechanically fastened or glued. Special joint adhesive sealing may be required to ensure air tightness.

Like untreated wood, wooden fibreboards must be protected against UV-radiation and humidity. With a wood moisture content of less than 20 per cent, these boards are highly resistant to wood pests and other sources of damage (bacteria, fungi, and insects).

Wood fibreboards are available as insulating plaster-base elements for exterior walls. They are also suitable as elements for composite or sandwich construction in combination with hardboard or gypsum board.

### Manufacture

In the wet manufacturing process, waste (from locally harvested coniferous trees is chipped and shredded. The chips are pulped with vapour in a reaction chamber and subsequently milled into fibres. Additives and, if required, wood preservatives are blended into the fibre slurry. The slurry is spread on a Foudrinier to create a flat fibrous mat, which is then dehydrated by extrusion or by applying negative pressure. In the final stage, the mats are shaped into boards and dried.

Thicker panels (25-30 mm and upwards) are manufactured by laminating several individual boards.

### Manufacturer@(selection)

Emfa Baustoff GmbH

GlunzAG

Gutex

Holzfaserplattenwerk Schönheide GmbH

Pavatex

Steinmann

### Bituminated Fibreboard [Asphalt-Treated Board; US]

[DIN 68752

Thermal conductivity:

$\lambda = 0.056-0.060 \text{ W/mK}$

Vapour diffusion resistance factor:

$\mu = 5-10$

Raw density:

$\rho = 200-350 \text{ kg/m}^3$

Building material classification:

B2

Thermal capacity:

$C = 630 \text{ kJ/m}^2\text{K}$

Application types:

T, TV

### Material

Bituminated fibreboards are porous wood fibreboards, manufactured with a bitumen additive.

A distinction is made between bituminated (fibreboards

- with 10-15 per cent bitumen additive (moisture-proof) and a water absorption rate of less than 25 per cent (BPH)

- with more than 15 per cent bitumen additive (increased moisture resistance) and an average water absorption of less than 20 per cent (BPH2).

### Application@

The primary areas of application are exterior walls, roof extensions and subfloors. Bitumen-impregnated wood fibreboards can be used under roof covering as water- and airtight layers. The bitumen content renders them resistant to moisture, rot, fungi and insects.

### Dimensions

Thickness [mm]:

16-25

Width [mm]:

[400-1,220

Length [mm]:

[2,440,2,500

### Manufacturer@(selection)

Emfa Baustoff GmbH

Gutex

Isofloc Wärmedämmtechnik GmbH

Pavatex

### Dimensions

Thickness [mm]:

6-80

Width [mm]:

400-1,220

Length [mm]:

1,200-2,500



**Cork**

DIN 18161-1  
 Thermal conductivity:  
 $\lambda_H = 0.040-0.055 \text{ W/mK}$   
 Vapour diffusion resistance factor;  
 $\mu = 5-10$   
 Raw density:  
 $\rho = 80-200 \text{ kg/m}^3$   
 Building material classification:  
 B2  
 Thermal capacity:  
 $C = 223 \text{ kJ/m}^3\text{K}$   
 Application types:  
 T, TR, TS

*Material*

Cork, the outer bark of the cork oak tree, is available - as natural or expanded granulated material (expanded cork, caking cork) - in the form of insulating panels and fill.  
 The cork oaks, predominantly indigenous to the western Mediterranean region, can be debarked every 8 to 10 years. They have a lifespan of 100 to 150 years.

*Applications*

Cork is mould and rot resistant even when thoroughly moist. However, exposure to moisture over an extended period may result in fungal decay.  
 Cork insulating boards are laid down loosely, then nailed, plugged or glued. Granulates are poured or injected. Insulating cork is especially suitable for use in areas subjected to pressure loads and as impact sound insulation. Cork can also be employed in composite insulating systems.

For invitations to tender and orders:

- Manufacturer
- DIN
- Application type
- Thickness
- Width
- Length

Calculated per  $m^2$

*Manufacture*

Cork is processed into insulating materials in a variety of ways depending on the intended use.

Natural granulated cork is manufactured by crushing raw cork; it is used without additives as insulating fill.

Expanded granulated cork is manufactured by adding superheated vapour to the natural granulated cork under pressure in a hermetically sealed container. The natural cork resin (suberin) shifts to the outside of the granules and bonds them to each other. The required vapour temperature depends on the resin content. The blocks are then cut into slabs or granulated.

Impregnated cork is manufactured by adding a bonding agent such as synthetic resin or bitumen to the heated granulate.

*Manufacturers)(selection)*

Cortex  
 Emfa Baustoff GmbH  
 Gradl & Stürmann  
 Heck Dämmsysteme GmbH  
 Henjes Naturschrot  
 Rdthel GmbH & Co KG  
 Zipse Korkvertrieb

*Dimensions*

Thickness [mm]:  
 20-100  
 Format [mm]:  
 500 x 1,000, 600 x 1,200

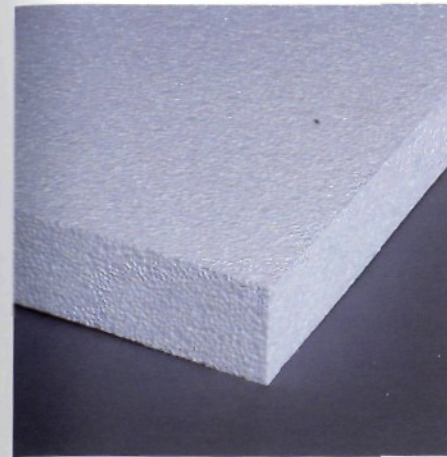

**Expandable Polystyrene (EPS)**

DIN 18164-1  
 Thermal conductivity:  
 $\lambda_i = 0.035-0.040 \text{ W/mK}$   
 Vapour diffusion resistance factor:  
 $\mu = 20-100$   
 Raw density:  
 $\rho = 15-30 \text{ kg/m}^3$   
 Building material classification:  
 B1  
 Thermal capacity:  
 $C = 43 \text{ kJ/rfK}$   
 Application types:  
 T, TV, TR, TS, IC

*Material*

Plastic foams are oil-refining products that are manufactured by foaming the raw material and simultaneously adding propellants or blowing agents. Plastic foams are porous in structure and are mainly available as HR-foams.

Expandable polystyrene, also called styropor, is a predominantly closed-cell, hard plastic foam. The "styropor" granulate is processed into boards, mouldings and sheets. The material is rot, mould and pest resistant. It is not resistant, however, to constant moisture or humidity.

*Application(s)*

It is typically used in non-ventilated flat roofs (which must be protected against hot bitumen), and composite insulation systems for exterior walls.  
 Rigid plastic foamboard is not very suitable for use in timber frameworks, however, because it does not compensate for wood shrinkage.

EPS boards are frequently employed in sandwich constructions in combination with a variety of materials, for example, with fibred cement panels as facade elements, or with timbering and plasterboard as wall and roof elements.

In floor construction, EPS boards are used as impact sound and thermal insulation. Loose polystyrene particles can also be used as fill.

For invitations to tender and orders:

- Manufacturer
- DIN
- Application type
- Grade
- Thickness
- Width
- Length

Calculated per  $m^2$

*Manufacture*

The product is manufactured in three stages:

- Frothing  
 The compact beads are heated with hot vapour and inflated under pressure with pentane blowing agent to make foam pellets.
- Intermediate storage  
 The beads are cooled and dried.
- Foaming  
 The trothed beads are further inflated with vapour into solid forms and bonded to each other. Block mouldings are produced to manufacture the polystyrene boards, which are saw-cut or hot-wire cut.

*Manufacturers)(selection)*

BASF  
 Joma  
 Schwenk

*Information*

Industrieverband Hartschaum e.V.

*Dimensions*

•Thickness [mm]:  
 10-200  
 Format [mm]:  
 500 x 1,000



For invitations to tender and orders:

- Manufacturer
- DIN
- Application type
- Thickness
- Width
- Length

Calculated per  $m^2$

For invitations to tender and orders:

- Manufacturer
- DIN
- Application type
- Thickness
- Width
- Length

Calculated per  $m^2$

#### Extruded Polystyrene (XPS)

DIN 18164-1

Thermal conductivity:

$\lambda_R = 0.030-0.040 \text{ W/mK}$

Vapour diffusion resistance factor:

$\mu_i = 80-200$

Raw density:

$\rho = 25-45 \text{ kg/m}^3$

Building material classification:

B 1.B2

Thermal capacity:

$C = 58 \text{ kJ/m}^3\text{K}$

Application types:

T, TR, TS

#### Material

Extruded polystyrene (XPS) is a closed-cell, hard plastic foam. It differs from expandable polystyrene (EPS) in the manner of manufacture. Extruded polystyrene foam is characterised by its low moisture absorption and resistance to rot, ageing and decay; it is not, however, resistant to UV-radiation.

#### Applications)

Extruded polystyrene foam is employed for all insulation purposes. It is not, however, used in manufacturing impact sound insulating boards. Its principal applications are the insulation of pitched roofs and perimeters.

Rigid plastic foamboard is not very suitable for use in timber frameworks, however, because it cannot compensate for wood shrinkage.

#### Manufacture

In the production of extruded polystyrene foam, polystyrene - which is heated and melted in an extruder - is foamed by admixing a blowing agent. The resulting foam is continuously pressed through air jets into boards, whose characteristic feature is their smooth, sealed foamed skin. They are suitable for use as perimeter insulation for building components that are in direct contact with the soil and as insulation for pitched roofs. For other uses, blocks are foamed and cut into panels.

#### Manufacturers)(selection)

BASF  
DOW Deutschland  
Gefinex

#### Information

Industrieverband Hartschaum e.V

#### Dimensions

Thickness [mm]:

20-200

Width [mm]:

600

Length [mm]:

1,250,2,500

#### Polyurethane (PUR)

DIN 18164-1

Thermal conductivity:

$\lambda = 0.020-0,030 \text{ W/mK}$

Vapour diffusion resistance factor:

$\mu = 30-100$

Raw density:

$\rho = 22-100 \text{ kg/m}^3$

Building material classification:

B 1 . B 2

Thermal capacity:

$C = 43 \text{ kJ/m}^3\text{K}$

Application types:

T, TR, TS, TRS

#### Material

Polyurethane is composed of various crude oil products with different cross-linking densities and raw densities. Polyurethane HR-foam is characterised by its low moisture absorption and its resistance to rot, ageing and decay. It is, however, not resistant to UV-radiation. In contrast to polystyrene, PUR HR-foam can withstand temperature stresses of up to 250 °C.

Polyurethane is manufactured as both HR-foam and in-situ foam.

- Polyurethane HR-foam is a strongly cross-linked, thermosetting synthetic material, which is usually foamed into a closed-cell structure (closed-cell ratio of approximately 90 per cent]. Open-cell grades are also manufactured for special applications. Boards are available in both laminate and non-laminate form.
- PUR in-situ foam is manufactured on site. It is used to insulate roofs and to fill and seal building joints of doors and windows, etc.

#### Application^)

PUR foam is used:

- as flat roof insulation (PUR HR-foam is resistant to hot bitumen),
- as insulation for high pitched roofs, between and underneath rafters,
- as insulation for external walls on ventilated facades (cavity walls),
- as a component in sandwich and composite construction.

Rigid plastic foamboard is not very suitable for use in timber frameworks, however, because it does not compensate for wood shrinkage.

#### Dimensions

Thickness [mm]:

10-300

Width [mm]:

500-1,200

Length [mm]:

1,003-3,000

#### Manufacture

PUR HR-foam boards are manufactured in two different processes:

In the double-belt process, the foamed blend (with pentane blowing agent] is applied to a bottom surface layer and then bonded to a top surface layer. Mineral fibrous mats, glass fibrous mats, paper, metal- or compound (sandwich) foil, roof sheeting and moisture-proof roof sheeting are used as surface layers.

In the block foam process, the reaction mixture is poured into an ingot mould. The resulting blocks are cut into boards once the foam has hardened and settled.

#### Manufacturers)(selection)

Bauder  
Correctthane  
Puren Schaumstoff GmbH

#### Information

Industrieverband Hartschajm e.V.



**Mineral Wool**

DIN 18165-1+2  
Thermal conductivity:  
 $\lambda = 0.035-0.050 \text{ W/mK}$   
Vapour diffusion resistance factor:  
 $\mu = 1-2$   
Raw density:  
 $\rho = 12-250 \text{ kg/m}^3$   
Building material classification:  
A 1, A2  
Thermal capacity:  
 $C = 115 \text{ kJ/n}^\circ\text{K}$   
Application types:  
T TV, TR, TS, TRS, TF, I, IC

**Material**

Mineral wool is a synthetic fibre manufactured from a glass, stone and slag smelt. It is supplied as insulation in the form of sheets, mats, felting or panels of differing density. A distinction is made, depending on the raw material used, between glass wool (yellow colouring) and rock wool (olive green colouring). Mineral fibre insulation, including mineral wool, must be protected against moisture. It is resistant to micro-organisms and pests and does not rot. Composite materials of felting and panels with paper-, aluminium- and synthetic laminate are available as required.

**Application<sup>^</sup>**

Mineral wool insulating materials have a wide range of applications as sound, impact sound and thermal insulation, with a special material for each particular use. Sheets are used on ceilings and walls as insulating and sound absorbing layers. Composite materials composed of mineral wool and paper/aluminium foil are designed with special edges so that they can be fastened between squared timbers (e.g. rafters).

Panels or boards have a variety of uses in walls, for example, on the exterior side of masonry beneath a weather protection layer, in composite insulating systems, and (provided permission has been obtained) as core insulation. They are used as impact sound insulation in floors. Due to their relatively high degree of compressibility, the thinnest possible mineral wool impact sound insulation panels should be used.

Since mineral wool is non-combustible, it is suitable in areas with special fire-protection requirements.

**Dimensions**

Thickness [mm]:  
20-200  
Width [mm]:  
600, 625, 1,200  
Length [mm]:  
1,200, 1,250, 6,000

For invitations to tender and orders:

- Manufacturer
- DIN
- Application type
- Thickness
- Width
- Length

Calculated per m<sup>2</sup>

**Manufacture**

Glass wool is composed of quartz sand, sodium carbonate (or: soda ash), limestone, dolomite, feldspar, borax, with a recycled glass content of up to 70 per cent.

Basalt or diabase, limestone, dolomite and flux additament are used to manufacture rock wool,

The raw materials are melted at a temperature of 1,200-1,400°C, before being blown or spun through fine nozzles, defibrated and subsequently felted into wool-like materials. Synthetic resins are also added as bonding agents. Water-repellent oils are employed to bind the fibre dust. Waterproofing and bonding agents are also used.

**Manufacturer(s)(selection)**

Deutsche Heraklith  
Deutsche Owens-Corning Glasswool  
Deutsche Rockwool  
Pfleiderer  
Saint-Gobin Isover G+H AG  
Thiiringer Dammstoffwerke



**Sheep's Wool**

Building authority certification:  
Z-23.11-1022  
Z-23.11-332  
Z-23.1.3.-253  
Thermal conductivity:  
 $\lambda_{\text{tr}} = 0.040 \text{ W/mK}$   
Vapour diffusion resistance factor:  
 $\mu = 1-2$   
Raw density:  
 $\rho = 20-80 \text{ kg/m}^3$   
Building material classification:  
B2  
Application types:  
T TV

**Delivery formats/dimensions**

Wool and braided wool packaged in sacks  
Wool/rolled felting:  
Thickness [mm]: 20-220  
Width [mm]: 450-1,000  
Length [mm]: 1,000-8,000

**Cotton wool**

Building authority classification:  
Z-23.11-251  
Z-23.11-308  
Z-23.11-1056  
Thermal conductivity:  
 $\lambda_{\text{tr}} = 0.040-0.045 \text{ W/mK}$   
Vapour diffusion resistance factor:  
 $\mu = 1-2$   
Raw density:  
 $\rho = 20-60 \text{ kg/rrl}^1$   
Building material classification:  
81, B2  
Application types:  
T, TV

**Delivery formats/dimensions**

Siting (thickness [mm]): 2-20):  
Width [mm]: 625, 1,200, 1,800  
Mats (thickness [mm]: 50-180):  
Width [mm]: 500-1,200

**Material**

Sheep's wool is one of the oldest materials used by humans to protect themselves against cold. Sheep's wool fibrous mats are composed entirely of shorn sheep's wool. Up to 50 per cent of all recycled wool is used for sheep's wool felt. With the addition of borax, sheep's wool is largely resistant to insects and mould fungi.

**Application<sup>^</sup>**

Sheep's wool is used in the form of insulating mats, braided insulation and packing wool to provide thermal and sound insulation in roofs, walls and ceilings; it is also employed in the form of felting as impact sound insulation.

According to various manufacturers, sheep's wool has an excellent moisture absorption capacity (up to 30 per cent), combined - in contrast with other fibrous insulating materials - with extremely good insulating properties.

**Material**

Cotton wool insulation is composed of the hull fibres (up to 97 per cent) of the cotton bush. The long fibres of the hulls contain more than 90 per cent cellulose. The insulating material contains borax additive (as much as 3 percent),

**Applications**

This material is used as thermal and sound insulation in roof, wall and ceiling cavities. Insulating feltings are employed as impact sound insulation. Cotton wool insulation is mould resistant. Damage caused by moths, carpet beetles, insects and rodents can be prevented.

For invitations to tender and orders:

- Manufacturer
- Certification No.
- Application type
- Delivery format
- Thickness
- Width
- Length

Calculated per m<sup>2</sup>

**Manufacture**

The wool is thoroughly washed with soap and soda. The cleansing agent is then completely removed through repeated rinsing in cold water. Next, the wool is mechanically bonded and impregnated. During the final rinse, some manufacturers add borax as well as a urea-derivative, such as sulcoforen, as a legally authorized preservative against keratin-digesting insects (e.g.. moths, carpet beetles). Some manufacturers also use polyester or cotton wool as binding fibres to improve the dimensional stability of insulating rolls with a thickness greater than 120 mm.

**Manufacturer<sup>®</sup>(selection)**

Doppelmayr  
Falke Game KG  
Klöber  
Purwooll GmbH  
ROWA F. Rothmund GmbH  
Thermowoll Dammstoff GmbH

**Manufacture**

Cotton harvested in tropical to subtropical cultivation areas is processed into fibrous mats, which are then layered to achieve the desired thickness. Cotton wool is available in the form of mats, felting, padding and injection wool, and as braided insulation.

**Manufacturers)(selection)**

Isocotton GmbH  
K + K ISO Baumwolle



### Flax

Building authority certification:

Z-23.11-239  
Z-23.11-276  
Z-23.11-1010

Thermal conductivity:

$\lambda = 0.040 \text{ W/mK}$

Vapour diffusion resistance factor:

$\mu = 1-2$

Raw density:

$\rho = 25 \text{ kg/m}^3$

Building material classification:

B2

Application types:

T, TV

### Dimensions

Thickness [mm]:

40,60,80, 100

Width [mm]:

500-1,200

Length [mm]:

10,000

### Hemp

Building authority certification:

2-23.11-1341,  
ETA 02/0015 (European certification)

Thermal conductivity:

$\lambda_{\text{H}} = 0.045 \text{ W/mK}$

Vapour diffusion resistance factor:

$\mu = 0.5-1$

Raw density:

$\rho = 20-40 \text{ kg/m}^3$

Building material classification:

B2

Application types:

T, TV

### Dimensions

Thickness [mm]:

20-240

Format [mm]:

575/600/625/635 x 1,200

1,000x2,000

### Material

Flax is a textile fibre (belonging to the group of bast fibres) harvested from the roughly 1-metre-long flax plant. As insulation, flax is resistant to mould and can absorb and release up to 20 per cent of its own weight in moisture.

### Application(s)

Insulating mats of flax are used for roof, wall and floor insulation.

Insulating feltings are used as impact sound insulation. Cavity flocks (insulating mats cut into small pieces) and shives (wooden parts of the stalks) are used to fill cavities, (or example, sound-boarded ceilings.

Flax, in the form of pipe casing, is also used to insulate ducts and pipes.

### Material

Hemp fibres are tear-resistant and also highly stress-resistant, which makes them suitable as impact sound insulation. Since hemp fibres do not contain protein, they are naturally protected against pests and mould, thus obviating the need for additives. Hemp fibres can absorb up to 18 per cent of their own weight in moisture and release the moisture when the air is dry. They therefore have a balancing effect on the interior climate. Hemp insulating materials are recyclable.

### Applications)

Hemp mats are used as thermal insulation in walls, ceilings and floors, as sub- or common-rafter insulation and as impact sound insulation (d = 15/20/30 mm) below floor screeds.

For invitations to tender and orders:

- Manufacturer
- Certification No.
- Application type
- Thickness
- Width
- Length

Calculated per  $m^2$

### Manufacture

After the harvest, the stalk of the flax plant is separated into seed capsules and leaves and then roasted to free the fibre bundles of bonding agents. These steps are followed by washing, drying, breaking, tumbling (separating the fibres from the wood of the stalks) and chopping. The cellulose content of the resulting short fibres constitutes the thermal insulating material. Polyester is usually added as a stabilising and binding fibre to achieve good recovery. Some manufacturers also include borax, soluble sodium or ammonium phosphate to protect the fibres against fire.

### Manufacturer(s)(selection)

Deutsche Heraklith GmbH  
Flachshaus GmbH  
Pavatex GmbH  
Stattbauhof GmbH  
Best Naturdammstoffe

### Manufacture

The cultivation of non-intoxicating types of hemp has been permitted in Germany since 1996. Hemp fibre is gathered from the fast-growing hemp plant, which can be harvested biannually. Safe and harmless agents, such as soda or ammonium phosphate, are added to provide flame protection. Hemp insulation is available in pure form and with an admixture of sheep's wool. The mixed grade must be protected against pests. Textile fibres, (e.g. polyester), are added for support.

### Manufacturer(s)(selection)

Emfa Baustoff GmbH  
Hock Vertriebs-GmbH & Co KG  
Saint-Gobin Isover G+H AG  
Treuhant AG



### Coconut Fibre

DIN 18165

Thermal conductivity:

$\lambda = 0.045-0.050 \text{ W/mK}$

Vapour diffusion resistance factor:

$\mu = 1-2$

Raw density:

$\rho = 50-140 \text{ kg/m}^3$

Building material classification:

B2

Thermal capacity:

$C = 22-57 \text{ kJ/nrK}$

Application types:

T, TV, I, IC

### Dimensions:

Boards:

Thickness [mm]:

13, 18, 20,23, 25, 28,40

Width [mm]:

625

Length [mm]:

1,250

Rolled felting:

Thickness [mm]:

20, 25, 35

Width [mm]:

400,500, 670, 1,000

Length [mm]:

10,000

For invitations to tender and orders:

- Manufacturer
- DIN
- Application type
- Delivery format
- Thickness
- Width
- Length

Calculated per  $m^2$

### Manufacture

The fibrous layer, which is up to 10 cm thick, is manually removed from the coconut and then stored for 6 to 10 months in seawater, during which process all perishable components decay (retting). The usable fibres are dried, aerated, refined and pressed and formed as needed.

### Material

Coconut fibre is gathered from the outer, fibrous layer of the coconut. It is available in the form of rolled felting, insulating mats or boards, braided insulating material and packing wool.

### Applications)

Coconut insulating mats are available as:

- screed insulating boards, multiple needle-felted and pressed layers, for wet and dry screed as well as for poured asphalt;
- coconut wall panels for airborne sound insulating facing shells and partitions;
- needle-felted coconut rolled felting for cavity insulation in walls and floors; thermal insulation for roofs and walls; sound insulation; fill material for door and window joints.

Coconut insulating materials are available in the form of boards and rolled felts.

### Manufacturers)(selection)

EZO Isolierstoffe GmbH  
Emfa Baustoff GmbH  
Röthel GmbH & Co KG  
Zipse Korkvertneb



### Cellulose

Building authority certification;  
Z-23.11-280  
Use is subject to compliance with  
DIN 18165-1 for fibre insulating materials.  
Thermal conductivity:  
 $K = 0,040-0,045 \text{ W/mK}$   
Vapour diffusion resistance factor:  
 $H = 1-2$   
Raw density:  
 $\rho = 30-80 \text{ kg/m}^3$   
Building material classification:  
B 1, B 2  
Thermal capacity:  
 $C = 100 \text{ kJ/m}^3\text{-K}$   
Application types:  
**T,TV**

#### Material

Old newsprint provides the base material for all cellulose flocks. Borate is added for protection against rot and flammability. Cellulose flocks are loose in structure and injected into cavities or onto horizontal, curved or inclined surfaces. Injection pressure compresses the flocks to a density of approximately  $45-60 \text{ kg/m}^3$  in roof pitches and  $60-70 \text{ kg/m}^3$  in walls.

#### Application(s)

Cellulose is typically used to provide thermal insulation in roof, wall and ceiling cavities. The mode of application varies: pouring or blowing for open ceilings; injection for roofs and ceilings; spraying for walls. According to **DIN 18165-1**, the insulating flocks cannot be assigned any specific type of application. They can only be employed in closed cavities. They must not be subjected to pressure loads and must be protected against damp. Compliance with the wood preservation regulation for hazard classification 0 under **DIN 68800** is a prerequisite for use of this material.

For invitations to tender and orders:

- Manufacturers
  - Certification No.
  - Application type
  - Thickness
- Calculated per  $\text{m}^3$

#### Manufacture

Cellulose is recycled newsprint, pulped from finely flocked stock, which is impregnated with borates (borax and boracic acid) to protect it against fire, rot and pest attack.

The paper is pre-shredded, the borate is added in pulverised dosages, and both components are blended in a milling process and mechanically bonded. The cellulose mix is freed from dust, slightly compacted and packaged in paper sacks.

#### Manufacturer(s)(selection)

Besin Mehren GmbH  
Dobry GmbH  
Climacell GmbH  
Climatizer  
C.F.F, Cellulose  
CWA Cellulose  
Homann Dämmstoffwerk GmbH & Co.KG  
Intercel GmbH  
Isofloc Wärmedämmtechnik GmbH  
Stattbauhof GmbH

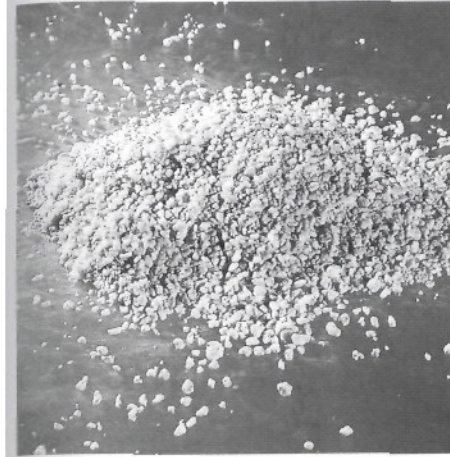

### Perlite

Non-standardised  
Building authority certified  
Thermal conductivity:  
 $\lambda_p = 0.55-0.66 \text{ W/mK}$   
Vapour diffusion resistance factor:  
 $\mu = 3-4.5$   
Raw density:  
 $\rho = 60-300 \text{ kg/m}^3$   
Building material classification:  
A 1, for bitumen casing  
B 2, for natural resin casing

#### Delivery formats/dimensions

Paper bags  
Panels:  
Thickness: 20-200 mm  
Format: 600x1,200 mm

### Swelling Clay

Non-standardised  
Thermal conductivity:  
 $\lambda = 0.13-0.20 \text{ W/mK}$   
Vapour diffusion resistance factor:  
 $\mu = 2-8$   
Raw density:  
 $\rho = 325-800 \text{ kg/m}^3$   
Building material classification:  
A1  
Thermal capacity:  
 $C = 252 \text{ kJ/nrK}$

#### Delivery format

Loosely packaged in bags of 50, 62.5

#### Material

The base material is crude perlite rock, an aluminium-siliceous rock resulting from volcanic activities with temperatures in excess of  $1000 \text{ }^\circ\text{C}$ . It is mined in open-pit mines in countries with natural deposits such as Greece and the United States. Expanded perlite contains a wide variety of additives, chiefly bitumen, natural and synthetic resins and mineral bonding agents.

#### Applications)

Expanded perlite is used as insulation in floors and roof slopes, as a levelling layer under floor construction, as sloping insulation on flat roofs and as core insulation in double-layered masonry. Perlite is also used for chimney linings and as a lightweight aggregate for gypsum plasters and mortar.

Owing to their extraordinary load capacity, perlite boards are even employed beneath screeds and floors that are subjected to high load stresses.

#### Material

Swelling clay is a mineral granulate composed of clay. Swelling clay is dimensionally stable, water repellent, rot resistant and also resistant to micro-organisms and pests. As a mineral material, it is non-combustible.

#### Application®

Swelling clay is used as cavity fill for sound and thermal insulation (e.g., in ceiling cavities) or loosely as a lightweight aggregate for bricks, plaster, lightweight concrete, etc.

For invitations to tender and orders:

- Perlite:
- Manufacturer
  - Delivery format
  - Certification No.
- Swelling clay:
- Manufacturer
  - DIN
- Calculated permVm<sup>3</sup>

#### Manufacture

The crude rock is crushed, ground and then flash-heated to over  $1200 \text{ }^\circ\text{C}$ . During this process, the rock softens, and as the combined water in it evaporates, the raw perlite expands to 15 to 20 times its original volume (rock foam). The outcome is a white granulate with granules measuring 0-6 mm in diameter.

The surface of the granules, which are composed of microscopic cells, is open-pored, providing good interlocking qualities for loose, dry in-fill. The surface is also highly temperature-resistant. Various agents are added to relieve the inherent sensitivity to moisture or to increase the compressive strength. Fibres and bonding agents are combined to produce compression-proof panels. (TR, TS)

#### Manufacturer(s)(selection)

Morgan Thermal Ceramics GmbH  
Perlite Dämmstoff GmbH

#### Manufacture

The clay is prepared, finely ground, granulated and fired in revolving kilns in a countercurrent process at roughly  $1,200 \text{ }^\circ\text{C}$ . The organic matter enclosed in the clay is burnt off. Supported by heavy oil, the clay granules expand while the surface melts to some degree and forms a sintered outer skin.

#### Manufacturer®(selection)

Fibrolith Wilms GmbH  
Leca Deutschland  
Lias Franken

#### Delivery format

Paper sacks of 12.5 kg and 13.6 kg



**Vapour Retarding Layer/Vapour Barrier**

DIN 4108-4

Vapour retarding layers or vapour barriers are essential layers in multi-shell or multilayer wall structures, whose importance with regard to building physics and construction engineering is increasing as ever greater requirements are placed on thermal insulation and energy savings.

**Material**

Vapour retarding layers are composed of coated or uncoated special papers and foils. They ensure that the outward diffusion of water vapour forming in a building can be metred and controlled through its thermal insulation. Permeated or condensed water vapour has to be dissipated either directly or by ventilation. A seasonal balance at least must be maintained to ensure that the thermal insulation remains serviceable,

Vapour barriers are vapour-tight sheets of plastic, metal foil or layered paper and/or synthetic materials, which prevent the outward diffusion of water vapour from the inside. Their vapour diffusion resistance is determined by the vapour diffusion resistance of the individual layers from the inside out. As a basic principle, each building element layer should permit more diffusion than the layer below it.

The effectiveness of a vapour barrier is fundamentally dependent on the technical and permanent connections that are made. Perforations and permeation can significantly reduce the functioning of vapour barriers.

**Properties**

The  $s_v$ -value, the water vapour diffusion-equivalent air-layer thickness, specifies by how much lower the flow of water vapour is through a building element layer in comparison to an air layer of equal thickness. The value is specified in metres and is the product of the thickness of the building material (s) and its water vapour diffusion resistance coefficient  $u$ .  $s_D = u \times s(m)$

Metal foils with a thickness greater than 0.05 mm are classified as absolutely vapour-tight under DIN 4108-4. A material layer with a diffusion resistance of  $s_D = 1500 m$  is considered vapour-tight for construction purposes. These materials can be used as vapour barriers.

A material with a diffusion resistance  $2 < s_D < 1500 m$  can be used as a vapour retarding layer.

Materials with an  $s_D$ -value  $< 0.3 m$  are considered diffusion-open.

Diffusion-open	$s_D < 0.3 m$
Vapour retarding layer	$s_D 2-1,500 m$
Vapour barrier	$s_D > 1,500 m$

Recommendations for sealing joints, overlaps, junctions and penetrations of vapour retarding layers and vapour barriers are contained in DIN 4108-7.

Building papers and sheeting, in addition to their function as a vapour retarding layer or a vapour barrier, can also perform the following functions in the structure of a wall or roof construction:

- Air-tight layer
- Windproof layer
- Waterproof underlay
- Moisture barrier
- Separating layer

Pay attention to the vapour diffusion resistance!

**Use**

Air-tightness is a basic principle for a wood construction designed to function in line with the requirements of building physics and construction engineering. The high insulation values, which are relatively easy to achieve, of the exterior surfaces will only be effective if they are not cancelled out by leakages involving condensation problems and draughts.

What is required is a continuous, airtight level with a minimal number of junctions and penetrations as well as joints and junctions which are not only technically

For invitations to tender and orders:

- Manufacturer
- $s_D$ -value
- Thickness
- Width
- Length

Calculated per  $m^2$

simple and safe to install, but also take into consideration inevitable deformations. Their correct installation can be checked using a blower door test.

This requirement applies to vapour-permeable or ventilated exterior wall constructions and especially to those where the airtight level is also the vapour barrier. The sealing materials must be co-ordinated and selected in accordance with wood construction requirements. As a rule, the air seal is attached inside and may be identical to the vapour retarding layer or vapour barrier,

The wind seal, however, is fastened on the outside of the thermal insulation. It protects the thermal insulation from excessive cooling and prevents exterior air from infiltrating, for instance, through the joints between the wooden construction and the thermal insulation. To satisfy the requirement of increasing vapour permeability from the inside to the outside, a diffusion-open wind seal should be chosen.

For the dimensions and materials see table p. 68 and 69

**Manufacturers)(selection)**

- Alkor Draka Handel GmbH
- Ampack Bautechnik
- A.W. Andernach KG
- Bauder
- Binné & Sohn GmbH&Co.KG
- Braas Dachsysteme GmbH
- Deutsche Heraklith GmbH
- Deutsche Rockwool Mineralwoll GmbH
- DIB Potthast GmbH
- Ewald Dörken GmbH
- EmfaBaustoffGmbH
- Forbo-Stamoid
- KibberGmbH&CoKG
- Koster Bauchemie GmbH
- Moll Bauökologische Produkte GmbH
- Röthel GmbH S Co KG
- Samt-Gobin Isover G+H AG
- Vedag AG
- Wanit Universal GmbH
- WIKa Isolier- und Dämmtechnik GmbH

**Damp-Proofing**

DIN 18195-1 to 10

Building seals that meet the requirements of DIN 18195 are designed to prevent damage caused by pressing or non-pressing water as well as by ground moisture on the outside along the bordering building elements.

Damp-proofing is also required to avert damage to wooden elements that could emanate from adjacent building elements such as concrete or masonry (building damp) or be caused by damp from the subsoil or weather.

For these seals, which are not included in DIN 18195, other types of bituminous sheeting can be used than listed bare bitumen sheeting, asphalt roofing felt, asphalt roofing seal sheeting, bitumen seal sheeting, asphalt sheeting with different interply sheets: e.g. thick PE foil or other flexible plastic sheeting.

**Dimensions**

- Bitumen sheeting
  - Thickness (mm): 4-5
  - Width [cm]: 100
  - Length [m]: 5
- Plastic sheeting
  - Thickness [mm]: 1-3
  - Width [cm]: 100,120, 130, 170,200
  - Length [m]: 10,20,25

Separating layers become necessary when different building materials are connected in such a way that their effectiveness is impaired or completely lost.

Typical examples of this are separating layers on anticapillary courses underneath reinforced concrete floor slabs, separating layers between impact-sound insulation and wet lines, or between sheet covering and timber formwork, etc.

The following materials can be considered for use as separating layers between different building elements:

- Polyethylene foil
- Polyester felts
- Foam mats
- Oil paper
- Sodium bicarbonate kraft paper

For invitations to tender and orders:

- Manufacturer
- DIN
- Thickness
- Width
- Length

Calculated by  $m^2$

**Descriptions**

Bitumen sheeting

Brief description	Designation
R500"	Asphalt roofing felt with roofing felt intermediate ply
G 200 DD	Asphalt roofing seal sheeting
V 13	Glass fibre asphalt roofing felt
J300D	Bitumen seal sheeting with jute cloth
Al 0.2 D	Bitumen seal sheeting with steel tape interply sheet
V60S4	Asphalt sheeting with glass fibre interply sheet
PV200 PYDD	Polymer bitumen Roofing felt with polyester fleece interply sheet
G200PYS5	Polymer bitumen sheeting with glass fibre interply sheet

**Plastic Sheetting**

Brief description	Designation
EPDM	Ethylene Propylene Diene Monomer
CSM	Chlorsulfonated Polyethylene
MR	Butyl rubber (isobutylene-isoprene elastomer)
NBR	Nitrile rubber (nitrile butadiene rubber)

**Manufacturers)(selection)**

- A.W. Andernach KG
- Paul Bauder GmbH Co.
- Georg Börner GmbH & Co.
- Braas GmbH
- DLWAG
- Phoenix AG
- Saar-Gummiwerk GmbH
- Vedag AG

**Information**

Industrieverband Bitumen-Dach- und Dichtungsbahnen e.V.  
Wirtschaftsverband der deutschen Kautschukindustrie e.V.

S <sub>D</sub> = u x d [m]	u	Thickness [mm]	Width [cm]	Length [m]	Material	Product	Company
0.008	15	0.50	100	100	wool fibre board, impregnant and cellulose fibre	Perkalor normal	WIKA
0.008	15	0.50	100	50	wool fibre board, impregnant and cellulose fibre, reinforced	Perkalor Diplex	WIKA
<0.02	-	-	150,280	100	high-pressure PE	Tyvek Soft	Klöber
<0.02	-	-	150	100	high-pressure PE	Tyvek Dry	Klöber
<0.02	-	-	150	50	high-pressure PE/PP	Tyvek Plus	Klöber
0.09	423	0.22	125	50	impregnated kraft paper	Sisalit 50	Ampack
0.12	-	-	250	25	special acrylate coating on polyester fleece	Stamisol DW	Forbo-Stamoid
0.2-5	-	0.005	200	30,60	Polyamid	Difunorm Vario	Saint-Gobin IsoverG+H AG
0.30	-	0.30	150	50	special PE fleece with microfibre structure	Herafol	Deutsche Heraklith
0.50	2,000	0.25	75,105,135	100	recycling cellulose, with glass fabric	pro clima	Moll KS+
0.80	-	-	200	50	diffusion-open PP spunbonded fabric	Tyvap	Klöber
0.80	-	0.20	165	100	sodium bicarbonate kraft paper	Volint	Klöber
2.00	8,700	0.23	150	50	kraft papers with flame-retarding paraffin intermediate ply and glass fibre mesh	Sisalex 500	Ampack
2.00	-	-	150	50	spun fleece with vapour retarding coating	Delta-Fol WS	Dörken
2.30	-	0.23	75,135	100	building paper reinforced with recycling cellulose paper	EMFA-PWD	Emfa
2.30	-	0.35	105	50	special paper made of building paper reinforced with cellulose	EMFA-PWS	Emfa
2.30	10,000	0.23	75, 105, 135	100	recycling cellulose	pro clima DB	Moll
2.30	10,000	0.23	14,21,75, 105, 135	100	recycling cellulose, with glass fabric	pro clima DB+	Moll
2.30	5,000	0.45	105	50	recycling cellulose, with glass fabric	pro clima DA+	Moll
2.90	-	0.20	100	100	double ply sodium bicarbonate kraft paper with glass fibre reinforcement	Difulint	Klöber
<3.00	-	0.18	150	25	laminated film made of PP and LDPE coating	Wandufol	Wanit
>3.00	-	0.25	150	25	double ply kraft paper and glass-grid vapour retarder	Wandufol	Wanit
4.39	17,560	0.25	100,125, 150, 215	50	laminate of two kraft papers and a glass fibre mesh	Sisalit 303	Ampack

S <sub>D</sub> = M x d [m]	u	Thickness [mm]	Width [cm]	Length [m]	Material	Product	Company
21	53,304	0.40	100	100	Paper one-sided coated	IMepa	WIKA
23	68,800	0.33	150, 180	100,50	PP fibre fleece with PP filling layer	Ampatex DB 90	Ampack
25	-	0.30	140, 280	100, 50	PP fleece with PP coating, transparent	DB 25	Bauder
26	77,000	0.33	100	100	plastic coated kraft paper	UmodaniO	WIKA
50	-	0.2	200	30,60	PE foil	Difunorm	Saint-Gobin IsoverG+H AG
58	187,000	0.31	150, 180	100,50	PP fibre fleece with PP filling layer	Ampatex DB 95	Ampack
75	300,000	0.25	400	25	PE foil	vapour barrier PE	Braas
100	-	0.20	200	50	Polyethylene	Rockfol PE	Deutsche Rockwool
100	-	-	150	50	Aluminium layer between polyester foil and mesh-reinforced PE foil	Delta-Fol Reflex	Dörken
100-130	-	0.1	392	50	laminate of two PE foils	PE vapour barrier	Köster (highly tearproof)
111	58,500	0.20	400,600	25,50	polyethylene	DIB vapour retarding sheeting	DIB Potthast
112	45,000	0.25	600	25	extruded high pressure polyethylene	Alkorplus 81010	Alkor
120	300,000	0.40	400	25	PE foil	vapour barrier fk	Braas
"130"	-	-	150	50	mesh-reinforced PE foil	Delta-Fol DS130	Dörken
155	62,000	0.25	400, 600	25,50	polyethylene	DIB vapour retarding sheeting	DIB Potthast
285	69,000	0.40	400, 600	25,50	polyethylene	DIB vapour retarding sheeting	DIB Potthast
310	125,000	0.30	100	100	kraft paper with plastic coating and aluminium foil	Umodan DS	WIKA
379	1,895,000	0.20	100,125, 150	50	two impregnated kraft papers with glass fibre mesh and one-sided aluminium coating	Insulex311	Ampack
>500	-	0.14	150	25	double-ply alu foil with intermediate glass mesh	Wandufol Technonorm	Wanit
620	1,240,000	0.50	100	100	kraft paper with plastic coating and aluminium foil	Umodan Super	WIKA
4,000	-	0.12	150	100	aluminium laminated foil with double-sided special plastic lamination	DIB aluminium laminated foil	DIB Potthast
4,500	11,250,000	0.40	122,200	50	two watertight kraft papers with an intermediate ply of bitumen and sisal fibres, one-sided aluminium coating	Insulex718	Ampack
vapour-tight	∞	2.50	110	50	PE with aluminium foil and polyester fibre	Umodan 3-Plus	WIKA

Dowels

Dowels are predominantly used as joints and fasteners subject to shearing stress.

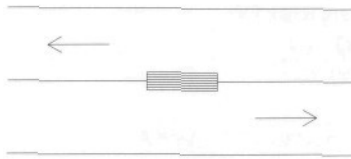

**Rectangular wooden dowels,** made of dry hardwood (groups A-C).

Use

Wooden rectangular dowels are inserted in the direction of the grain into recesses in the elements to be connected. They are secured with locking bolts.

Ordering

Hardwood dowels  
Number l x b x d in mm  
Wood species  
Timber quality

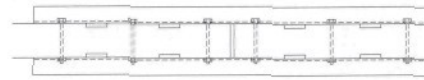
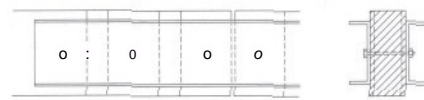

**Rectangular anchor made of steel.**  
Flat steel anchors

Use

Flat steel anchors are inserted into recesses across the grain, held with splices and secured with locking bolts.

Ordering

Flat steel anchors  
Number l x b x d in mm  
Steel quality  
Surface

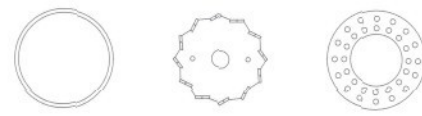

**Specially designed anchors**  
DIN 1052-2

Use

Permissible load and installation requirements; minimum timber dimensions; minimum spacing and initial wood lengths; size and depth of cut; hexagonal stud bolts matching the anchors as per DIN 1052-2

**Type A Anchor** Split ring connector (shear plate previously Appel System)  
Ø 65-190 mm

**Type B Anchor** Split ring connector (round wooden dowel made of oak; previously Kiibler System)  
Ø 66 and Ø 100 mm

**Type C Anchor** Force fitted dowel (previously Bulldog System)  
Ø 48-165 mm

**Type D Anchor** Force fitted dowel (previously Geka System)  
Ø 55-115 mm

**Anchor type E** Split ring connector, force fitted dowel (previously Siemens-Bauunion System)  
Ø 55 and Ø 80 mm

**Transverse connector** for cross-grain joints with a fitting or wind rod with cross thread in the corresponding bore.

Ordering

Quantity  
Type of anchor  
one-sided/two-sided  
plates

E.g. 2x2 anchors Ø 65-A  
plate Ø 58/6

*Manufacturers) (selection)*  
Bierbach GmbH S Co. KG  
Bulldog-Simpson GmbH



**Anchors**  
DIN 1052

Material

Anchors are pin-shaped fasteners made of round steel with headless chamfered ends; they are driven into pre-drilled holes. The bore must not be greater than the diameter. Minimum diameter 6 mm, in use 8-10-12-16 mm. Lengths 60-160 mm.

Use

Fitted by hand; the number and size of anchors required is to be calculated in relation to the load and type of load and to the thickness of the material and the installation location.

The anchor spacing is determined in relation to the diameter and to the position of the anchors vis-a-vis the load-bearing edge and the direction of the grain. Steel sheet timber joints using anchors require a minimum thickness of 3 mm for the internal sheets.  
At least 2 anchors are required per joint.

Material

Steel S 235, S 275, S 355  
in accordance with EN 10025  
Surface galvanised/stainless steel

Ordering

DIN  
Diameter  
Length  
Steel quality  
Surface

E.g. S Anchor DIN 1052 Ø 16x160  
S 235, galvanised

*Manufacturers) (selection)*  
Bossard AG Schrauben  
Bulldog-Simpson GmbH

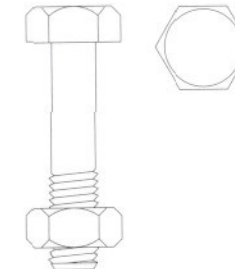

**Bolts**  
Bolts DIN 601, DIN 931, DIN 933, DIN 6914

Material

Bolts are pin-shaped fasteners made of round steel with heads, threads and nuts; they are driven into drilled holes with a maximum diameter 1 mm greater than their own, with washers on each side, Diameter M8-M24 (for load-bearing connections greater than 12 mm), Length 16-200 mm.

Bolts should be fitted so that they can be re-tightened to compensate for wood shrinkage.

Use

The numbers and dimensions of the bolts are calculated in relation to the different hole soffit strengths, e.g. of solid wood, glued laminated timber, wood-based material or sheet steel-to-timber joints. The direction of the grain must be taken into account when determining distances to the load bearing and non-load bearing edges.

Ordering

Bolts  
Steel quality 3.6, 4.6/4.8, 5.6/5.8, 6.8 in accordance with EN 20 898  
Surface hot-dip galvanised

E.g. BM 16(Ø 16) DIN 1052

*Manufacturers) (selection)*  
Bossard AG Schrauben

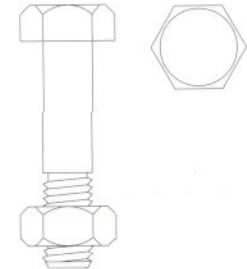

**Shear pins**  
DIN 7968

Material

Shear pins are bolts, which - like anchors - are driven into tight pre-drilled holes. Diameter M12-M24, Length 35-100 mm.

Use

Shear pins are used for securing anchor connections.

Ordering

Steel shear pins  
Surface hot-dip galvanised  
Diameter, DIN

E.g. PBMi6(Ø 16)  
DIN 1052

*Manufacturers) (selection)*  
Bossard AG Schrauben

**Screws**



**Wood screws**

DIN 95 Raised countersunk head wood screw, slotted  
 $d_s = 3-6$  mm  
 $l = 12-80$  mm

DIN 96 Round head wood screw, slotted  
 $d_s = 3-6$  mm  
 $l = 10-80$  mm

DIN 97 Countersunk head wood screw, slotted  
 $d_s = 3-8$  mm  
 $l = 10-100$  mm

DIN 571 Hexagon head wood screw  
 $d_s = 4-20$  mm  
 $l = 20-350$  mm

**Use**  
 The screw spacing as for pre-drilled nails.  
 Pilot hole:  
 smooth shank with  $d_s$ ,  
 threaded portion with  $0.7 d_s$ .  
**Load-bearing assemblies:**  
 Nominal diameter  $d_n = \text{min. } 4$  mm  
 Observe minimum thicknesses of building elements to be connected.

**Material**  
 Steel • natural bright  
 • galvanised  
 • nickel-plated  
 • brass-plated

**Ordering**  
 Quantity  
 Abbreviation Sr  
 Nominal diameter x length in mm  
 DIM  
 Surface

E.g. 10 x Sr 0 8 x 50 - DIN 97 galvanised.

**Manufacturer® (selection)**  
 Altenloh, Brinck + Co  
 Bierbach GmbH & Co. KG  
 Bossard AG Schrauben  
 MAGE Geriring GmbH  
 Adolf Würth GmbH & Co. KG

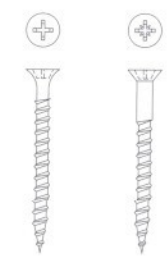

**Dry wall screws**

DIN 18182 Dry wall screws for fastening plasterboard, phosphated  
 $d_s = 3.5$  mm  
 $l = 25-70$  mm

non-standardised chipboard screws countersunk (Spax) with  
 • cross recessed head,  
 • posidrive cross recessed head,  
 • Torx hexagon socket  
 $d_s = 2.5-10$  mm  
 $l = 10-400$  mm

**Use**  
 Self-tapping, usually inserted without pilot holes.

**Material**  
 Steel • galvanised  
 • phosphated (partially)  
 • stainless

**Ordering**  
 Quantity  
 Abbreviation Sr/Type  
 Nominal diameter x length in mm  
 DIN (for dry wall screws for fastening plasterboard)  
 Surface

E.g. 10 x Sr 0 3.5x40-DIN 18182 phosphated

**Manufacturer(s)(selection)**  
 Altenloh, Brinck + Co  
 Bierbach GmbH & Co. KG  
 Bossard AG Schrauben  
 Adolf Würth GmbH & Co. KG

**Staples**



**Staples**

U-shaped bent wires, Diameter  $d_n$  1.2-2.0 mm. Back min. 15 mm. Length of shank approx. 30-90 mm.

**Use**  
 Fitted by hand or with a nail gun, in accordance with the German building authority certification.

**Material**  
 Steel - electrogalvanised  
 • rustproofing paint

**Ordering**  
 Staples  
 Wire diameter  $d$ , x length of shank  $l_n$   
 $d_n, l_n$  in mm  
 Staple spacing  $e$  in mm

E.g. Kl 1.53x44  $e = 7.5$

**Manufacturer(s)(selection)**  
 Raimund Beck KG  
 Joh. Friedr. Behrens AG  
 Bostitch GmbH  
 Duo-Fast GmbH  
 Haubold-Kihlberg •  
 Karl M. Reich  
 Paslode GmbH

**Nails**

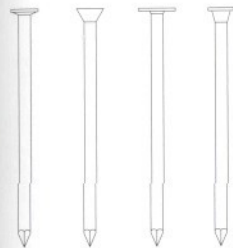

**Nails**

IDIN 1151 wire nails  
 \*DIN 1143 machine nails

Smooth shank, mostly round nails. Diameter  $d_n$  from 1.8 to 8.8 mm. Length  $l_n$  from 35 to 260 mm. Countersunk, deep countersunk, compression, flat-head, clout, round-head or lentil. Head diameter in accordance with EC 5 min.  $2 d_n$ .

**Use**  
 The numbers and dimensions of the nails (used are to be calculated to take into account the material, its thickness and the installation location (single-, double- or multi-jointed). The impact depth and the spacing of the nails from the edge and from each other is dependent on the thickness of the material, the wood species and grade as well as on the materials that are to be jointed (e.g. solid wood with wood-based material, steel, concrete....). By using pilot holes ( $< 0.9 d_n$ ), the splitting effect of the nails can be diminished, the spacing reduced and the load-bearing capacity increased. Nails should not be used in cross-grained timber, not even for lower level building elements.

**Material**  
 Steel • natural bright  
 • electrogalvanised  
 • hot-dip galvanised  
 • possibly tempered  
 • stainless  
 Aluminium (partially); copper (partially)

**Ordering**  
 Type of nail, DIN,  
 Diameter  $d_n$  x Length  $l$   
 $d_n$  in 1/10 mm,  $l_n$  in mm  
 Material  
 Surface

E.g. nails 38x100 DIN 1159, steel hot-dip galvanised

**Manufacturer(s)(selection)**  
 Bierbach GmbH & Co. KG  
 Bossard AG Schrauben

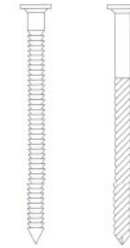

**Special nails**

Special nails, with the German building authority certification, in load-bearing capacity categories I - III. V.a. for nailed joints using sheet steel brackets.

**Groove, ridge/anchor nails** with horizontally profiled shank (barbed profile). Diameter  $d_n$  from 2.5-6 mm. Length  $l_n$  from 35-100 mm.

**Self-piercing screws/rafter nails** with screw threads. Diameter  $d_n$  of 4.2 and 5.1 mm, Lengths  $l_n$  from 100-320 mm.

**Use**  
 Use in accordance with the German building authority certification

**Material**  
 Steel • electrogalvanised  
 • phosphated  
 • stainless

**Ordering**  
 Type of nail  
 <math>\leq</math>  
 Material  
 Surface

E.g. ridge nail 4/50, electrogalvanised product..... load-bearing capacity category III

**Manufacturer(s)(selection)**  
 Bierbach GmbH & Co. KG  
 BMF Holzverbinder GmbH  
 Bulldog-Simpson GmbH  
 GH-Baubeschläge Hartmann GmbH

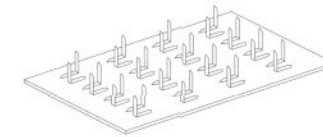

**Nail plates**

These are 1-2 mm thick steel sheets with nail or claw-shapes punched and bent out on one or both sides. The German building authority certification has been issued for the different systems e.g. BAT-Muttm, BMF, Gang-Nail, Hydro-Nail, TTSTwinaplatte.

**Use**  
 The size of the nail plates must be calculated. The nail plates are pressed into the equally thick (single) timbers using hydraulic jacks.

**Material**  
 Hot-dip galvanised steel

**Ordering**  
 Nail plates  
 Size b x h in mm, Type

E.g. NaPl 66x166 GN200

**Manufacturer(s)(selection)**  
 Eleco Bauprodukte GmbH (Gang-Nail)  
 Mi-Tek Industries GmbH (Hydro-Nail)  
 J. Wolf GmbH & Co Systembau KG  
 (Wolf Nagelplatten)

**Information**  
 Informations- und Gütegemeinschaft der Nagelplattenverwender e.V.

**Sheet Steel Brackets**

Sheet steel brackets are made out of 2-4 mm thick sheet steel, punched and cold-formed.

A German building authority certification has been issued for the various shapes and their mountings, The terms used to describe the same fastenings vary from supplier to supplier.

The selected sheet steel brackets do not represent the complete product range, and relate to the forces appearing in the examples chosen.

The use of modern beam constructions has rendered traditional carpentry joints affordable once again. For this reason they are being increasingly used in modern wood construction.

**Use**  
Sheet steel brackets are fastened with authorized special nails that are chosen according to the installation location, (wood-to-wood, wood-to-concrete/steel)

**Material**  
Hot-dip galvanised steel,  
Stainless steel (partly)

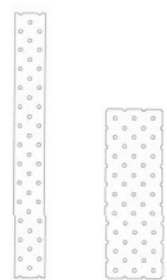

**Perforated steel strips**

**Use**  
As connectors for smaller constructions.

**Dimensions**  
20 x 1.0/1.5 mm  
25x2.0 mm

**Ordering**  
Dimensions, Type  
Nail type,  $d_n \times l_n$

**Canvas bands**

**Use**  
For bracing roof constructions. Tighten to ensure the load-bearing capacity e.g. using a ratchet clamp.

**Dimensions**  
40 x 2.0/3.0 mm  
60x2.0 mm  
80 x 2.0 mm

**Ordering**  
Dimensions, Type  
Nail type,  $d_n \times l_n$

**Flat connector**

Made of perforated panels in different, partially standardised dimensions.

**Use**  
For connecting flat building elements.

**Ordering**  
Dimensions, Type  
Nail type,  $d_n \times l_n$

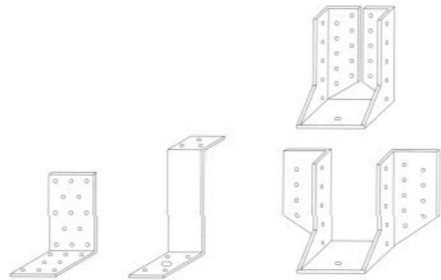

**Angle connectors**

As a perforated plate angle or from punched sheet

**Use**  
For connecting and fastening.

**Ordering**  
Dimensions, Type  
Nail type,  $d_n \times l_n$

**Z-Profile**

**Use**  
For the frontal fastening of the cross-beams to the main beam.

**Ordering**  
Dimensions b x h (mm)  
Manufacturer, Type  
Nail type,  $d_n \times l_{ri}$

**Beam hangers**

One or two-piece, sides bending inward or outward.

**Use**  
To fasten beams to beams/walls.

**Dimensions**  
For wood widths from 36-200 mm with fixed heights.  
Customised dimensions may sometimes be ordered.

**Ordering**  
Dimensions  
Manufacturer, Type  
Nail type,  $d_n \times l_n$

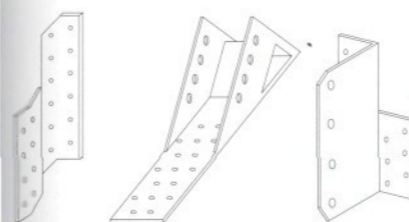

**Rafter-to-purlin connectors/purlin anchors**

**Use**  
For connecting crossing beams.

**Ordering**  
Manufacturer, Type  
Nail type,  $d_n \times l_n$

**Rafter foot joints/rafter holders**

**Use**  
For connecting rafters to inferior purlins or ceilings.

**Ordering**  
Manufacturer, Type, Length  
Nail type,  $d_n \times l_n$

**Main and cross beam-connectors/ integral connectors**

**Use**  
For connecting main and cross beams. Fastened to the main beam/pillar with special nails; slotted into the crossbeam and fixed with anchors.

**Dimensions**  
Heights from 80-240 mm

**Ordering**  
Manufacturer, Type  
Anchor/nail type,  $d_n \times l_n$

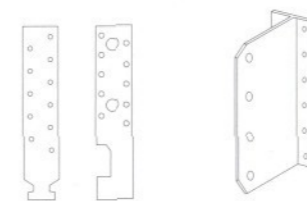

**Track anchors/profile anchors/wood connection anchors**

**Use**  
To fasten wooden elements into anchor tracks or with steel profiles.

**Ordering**  
Manufacturer, Type, Length  
Nail type,  $d_n \times l_n$

**Beam supports/suspended supports (T-shaped)**

**Use**  
For fastening crossbeams to the main beam or from beams to pillars. Fastened to the main beam/pillar with special nails; slotted into the crossbeam and fixed with anchors.

**Material**  
Hot-dip galvanised steel

**Ordering**  
Type, Quantity, Dimensions  
Nails/anchors

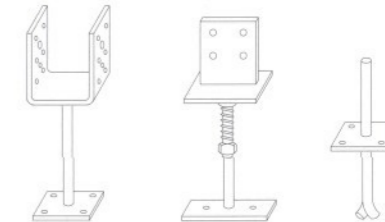

**Pillar bases**

**Use**  
Pillar bases (pillar bracket, post holder) serve to connect the pillar with the foundation or the ceiling. The connection is made by fixing base plates and dowels onto the concrete or by using ribbed rock dowels and grouting in the recesses in the concrete.

A distinction is made between the following types:

- Pillar base made of U-shaped bent flat steel with a welded-on wing rod or circular tube. Fastened with wood screws or anchors, fixed or height adjustable.
- Pillar base made of T-profile with welded-on wing rod or circular tube. Fastened with wood screws or anchors, fixed or height adjustable.
- Pillar base made of round steel or threaded rod with plate (glulam pillar support). Drilled and secured with a steel spike and if necessary glued, fixed or height adjustable
- Pillar base made of two flat steel profiles. Fastened with wood screws

**Ordering**  
Company-specific type designation

**Manufacturer(s) (selection)**  
Hot-dip galvanised steel  
Bierbach GmbH & Co. KG (BILOFormteile)  
BMF Holzverbinder GmbH  
Bulldog-Simpson GmbH  
GH-Baubeschläge Hartmann GmbH

## Wood Preservation

DIN 68800 1 to 5  
DIN 68364  
DIN EN 350-2  
DIN EN 460

Wood and wood-based materials are at risk from vegetable pests (fungi) and animal pests (insects). When infestation occurs, the outward appearance, the efficiency and the load-bearing capacity of wooden structures can be reduced to such an extent that they are completely destroyed.

*Fungi* require organic material (cellulose) for their development. They thrive particularly well in moist, warm areas without an air-flow. There are different types of mould, e.g. "real dry rot". As a rule the rot caused by fungi requires a wood moisture content of at least 20 %.

*Insects*, primarily beetles, e.g. wood ticks, use the sap area of the wood (predominantly softwood), as a source of food and to house their larvae. The fully developed ticks leave the wood through characteristic entrances. Not only living trees can be attacked, but also dry built-in timber. A wood moisture content of at least 10% is a precondition for infestation.

*Wood preservation* is subdivided into remedial wood preservation, which is necessary when infestation has already taken place, and preventative wood preservation, which stops infestation by destroying the preconditions under which the pests thrive.

*Preventative wood preservation*  
Preventative wood preservation can be achieved in several ways:  
- wood selection  
• wood preservation by design  
• chemical wood preservation

**Wood Selection:**

It is important to select well-dried and seasoned timber (wood moisture content  $u < 20\%$ ) and, where possible, to use a timber species with great durability or high resistance (see appendix).

**Structural wood preservation:**

This must be taken into consideration during the design phase e.g. when choosing the location of the building, designing the facade or planning protective roof projections. When working out the details, however, what must be avoided, above all, is contact to the ground, the formation of condensation, and continual moisture penetration of the wood by rain and splashing water. Damp timbers must be able to dry out. Thus a fundamental aspect of structural wood preservation involves aerating and ventilating the construction and the building element layers in order to allow any moisture to escape.

**Chemical wood preservation:**

Fungus and insect infestation should be prevented by using chemical wood preservatives.

DIN 68800-3 differentiates between chemical wood preservatives for:

- load-bearing and reinforcing wooden building elements
- non-bearing timbers which are dimensionally unstable
- dimensionally stable non-bearing timbers for windows and exterior doors

Preventative wood preservation is compulsory for load-bearing building elements. However chemical wood preservatives are only required for certain hazard classes, which are listed in DIN 68800-3 (see appendix).

The standard merely makes recommendations for non-bearing building elements which are dimensionally unstable. If written agreement has been reached between the architect and the builder, the wood need not be chemically preserved. Large-area application of wood preservatives should generally be avoided on the interior.

Chemical wood preservatives need not be used on windows and exterior doors if heartwood complying with certain durability grades is used (see appendix).

Durability grades in accordance with DIN 1052:

Grade	Description
1	very durable
2	durable
3	reasonably durable
4	not very durable
5	non-durable

**Hazard classes:**

Under DIN 68800-3, timber building elements and wood-based materials are allocated a hazard class ranging from GK 0 to GK 4 - not at risk to highly at risk - according to their area of application. Hazard class 0 does not require chemical wood preservation.

The application of chemical agents is not mandatory for classes GK 1 to GK 4 either, e.g. if timbers are used which are considered sufficiently "naturally durable" for the hazard class in question.

A special certificate can also be obtained to assign a structure to a lower hazard class. To obtain this certificate, special structural measures must be taken to destroy destructive fungi and prevent insects from accessing covered timbers.

A wood moisture content of below 20 per cent is required to avoid fungal decay. Insect attacks can be prevented by taking structural protection measures, e.g. by using suitable cladding or by keeping the wood moisture content below 10 per cent. If the wood remains open and can be inspected for insect attacks, chemical wood preservatives can also be avoided, e.g. in undeveloped roof trusses, if accessibility is ensured.

Nearly all load-bearing and reinforcing building elements can be classified as GK 0, with the exception of sills (GK 2). Chemical wood preservatives can also be dispensed with here if sap-free pine, larch or Douglas fir is used.

**Chemical wood preservatives:**  
Wood preservation by design should be given priority in every case when building wood constructions. If it is pursued consistently chemical wood preservatives can be avoided completely. Even under DIN, preventative chemical wood preservation is only a supplementary measure, and should be taken only when wood selection and design measures prove inadequate.

DIN 68800-3 specifies how the wood preservatives are to be applied:

- according to the inspection grades:
  - insect repelling Iv
  - inimical to mould P
  - weatherproof W
  - inimical to mildew E,
 each preservative can be applied individually or in combination depending on the hazard class.
- according to the wood species (round timber, sawn timber, laminated wood ...)
- according to the method of application (painting, spraying, dipping, borehole impregnation, vacuum and boiler pressure impregnation ...), including possible pre-treatments of wood species that are difficult to impregnate and the appropriate amounts to be applied for the hazard classes stipulated, whilst observing occupational health and safety measures.

Pay attention to the manufacturers' instructions.

Wood preservatives can be divided into:

- water soluble wood preservatives,
- solvent based wood preservatives,
- oleaginous wood preservatives.

**Water soluble wood preservatives:**

These preservatives contain inorganic or organic salts as agents which act as biocides.

A problem with inorganic water-soluble wood preservative salts is leaching caused by moisture, e.g. rain. Salts for hazard classes 1 and 2 are always leachable and need to be covered on site to protect them against moisture. Non-leachable salts for hazard classes 3 and 4 contain chromates (chrome-VI-compounds) and require a fixing period of several weeks in the wood. They need to be stored and protected from rain during this time.

Organic water-soluble salts are approved for hazard classes 3 and 4 and fix in wood without the addition of chromates.

**Solvent based wood preservatives:**

These comprise organic solvents and organic compounds which act as biocides. There is a controversial public debate about some of the fungicides and insecticides used (e.g. pyrethroid). Specific problems arise when pentachlorophenol (PCP) and lindane-containing agents are used indoors. For this reason PCP has been banned in Germany since 1990.

**Oleaginous wood preservatives:**

These are creosote compounds and creosoles.

**Processing:**

For reasons of occupational health and safety during processing, and to protect subsequent occupants from exposure to the agents and solvents contained in the wood, it is principally recommended that closed equipment be used to introduce the preservatives into the wood (boiler pressure impregnation, possibly also through impregnation, spray tunnel procedure).

The processing of wood preservatives on the construction site should be limited to the treatment of sawn edges, etc. Furthermore, the wood preservative should be applied by brush and not sprayed.

**Identification:**

Only products whose effectiveness and harmlessness have been demonstrated in tests may be used as chemical wood preservatives. They are subject to the approval mark regulation of the German *Länder* and are issued with the Institute of Structural Engineering in Berlin approval mark when their usability has been proven,

The area of constructed wood that has been treated must be provided with long-term visible identification by the contractor in accordance with DIN 68800-3.

**Waste disposal:**

Remains of wood preservatives as well as empty containers and contaminated packages are hazardous waste. Timber treated with wood preservatives must be incinerated as hazardous waste. Landfilling is prohibited.

**Manufacturer(s) (selection)**

AURO-Pflanzenchemie GmbH  
Beeck GmbH & Co KG  
Desowag GmbH  
Kulba-Bauchemie GmbH  
Leinos-Naturfarben GmbH  
Livos Pflanzenchemie GmbH  
RCH Fluorchemie GmbH  
Remmers Chemie GmbH & Co  
Wehl GmbH  
Dr. Wolmann GmbH

**Information**

The Deutsche Institut für Bautechnik (DIBt) Berlin (German Institute for Structural Engineering) issues a list of approved wood preservation products annually.  
Gutegemeinschaft Holzschutzmittel e.V.

**Joint sealing tapes**

DIN 18542

*Material*

Open-pored and closed-cell materials are used for joint sealing tapes.

Common types of sealing tapes are:

- foam sealing tape
- silicon sealing tape
- butyl rubber tape

Open-pored sealing tapes are made of polyurethane soft foam, for example, which is impregnated with pre-set flame-retardant synthetic resin, partially impregnated with bitumen, and can be pre-compressed at the factory for the application in question.

Closed-cell materials made of plastic are usually used for damp-proofing.

Open-pored materials have good sound insulation properties, but are only effective as damp- and wind-proof seals when compressed.

Joint sealing tapes are available as single or double-sided adhesive tapes.

*Dimensions:*

Length of reel [m]: 2-10, according to thickness

Thickness (uncompressed) [mm]: 10-150

Width [mm]: 10-1,000

For invitations to tender and orders:

- Manufacturer
  - Thickness
  - Width
  - Length
  - Colour
- Calculated per metre

*Processing:*

Sealing tapes are normally supplied pre-compressed (to approx. 20 per cent of the original thickness), whereby the retraction to the width of the joint is so gradual that it allows sufficient time during application to position the tape into the joint.

The seal effect of the joint sealing tape depends on its residual compression when in position:

< 20 %	Delivery condition
up to 25 %	requirements in accordance with DIN 18542
up to 35 %	seals against strong rain, good sound insulation
up to 50 %	[ water repellent, draught-proof, dust-tight
100%	original thickness

The adhesive strength at the edges of the joints is primarily determined by the restoring force of the expanding tape. The self-adhesive tape surface serves as an application aid,

*Manufacturers (selection)*  
Hanno-Werk GmbH & Co.KG  
Henkel Bautechnik GmbH  
Henkel Teroson GmbH  
Nlbruck Bautechnik GmbH  
KAWOKarlWolpers  
Sika Chemie GmbH



**Built Examples**

- 81 Temporary Bank in Nuremberg  
ami architekturwerkstatt
- 82 Weekend House in Vallemaggia  
Robert Briccola, Gibiasco
- 84 House near Bad Tölz  
Fink + Jocher, Munich
- 86 Church Community Centre  
and Youth Centre in Lenting  
Andreas Meek und  
Stephan K6ppel, Munich
- 88 Housing Development in Trofaiach  
Hubert Riess, Graz
- 90 Lakeside Bathing Facilities in Zug,  
Switzerland  
Alfred Krahenbühl, Zug
- 92 School Building in St Peter,  
Switzerland  
Conradin Clavuot, Chur
- 94 Media Library in the Cantonal School  
in Kusnacht  
Béatrix & Consolascio mit  
Erich Maier, Erlenbach
- 96 Parquet Showrooms in Lmdau  
Karl Theodor Keller, Munich

**[Temporary Bank in Nuremberg**

ami architekturwerkstatt

**[Matthias Loebermann, Nuremberg**

The "Blue Box" meets the requirements of the brief by providing a flexible, low-cost, temporary structure with a pleasant internal ambience. The modular system consists of a basic unit 3 m wide and 9 m long. Three modules are combined here to create a single structure 9 x 9 m on plan with a room height of 2.50 m. (The elements are laid on a supporting base, consisting of three beams. The wall, roof and floor panels are in timber-frame construction with insulation. To reduce the span of the minimally sloping roof, a row of columns was inserted along

the middle of the space. A room-height window can be installed in every module, with pivoting louvres to provide sunshading. The system can also be used for exhibition or information pavilions.

03 DETAIL 4/2001

- 1 roof construction, waterproof membrane  
19 mm three-ply laminated sheeting  
40 mm ventilated cavity; 40-80 mm wood finings  
160 mm thermal insulation;  
80/160 mm timber rafters  
15 mm oriented strand board
- 2 softwood casement with insulating double glazing
- 3 30 mm five-ply larch laminated sunshade louvres
- 4 flat steel movable fixing for louvres

Isometric (not to scale)  
Vertical section scale 1:20

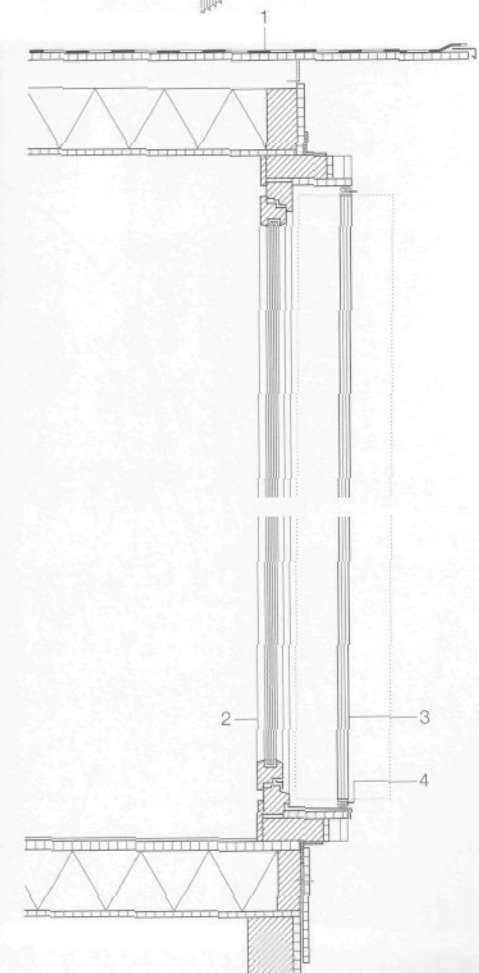
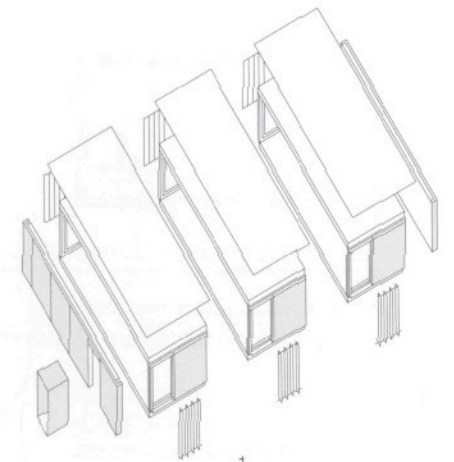



**Weekend House in Vallemaggia**

Reflecting the tradition of the Walsen Valley granaries, this small weekend house was designed to impinge as little as possible on the natural surroundings. The siting of the simple cubic volume allows for later additions. Raised on four corner piles, it seems to hover above the Alpine meadow.

The ground floor houses the entrance, living and dining areas, with an integrated kitchen strip. The living realm extends out into a sheltered loggia. On the upper floor are two simple sleeping cells and a shower. Apart from the concrete piles and the raking, welded-steel porch, the house

is entirely in timber. The structural elements are in fir. Externally, the house is clad on all faces with larch boarding. Internally, it is lined with three-layer laminated sheeting. /Q DETAIL 3/2001

Roberto Briccola, Giubiasco

Floor plans • Sections scale 1:200

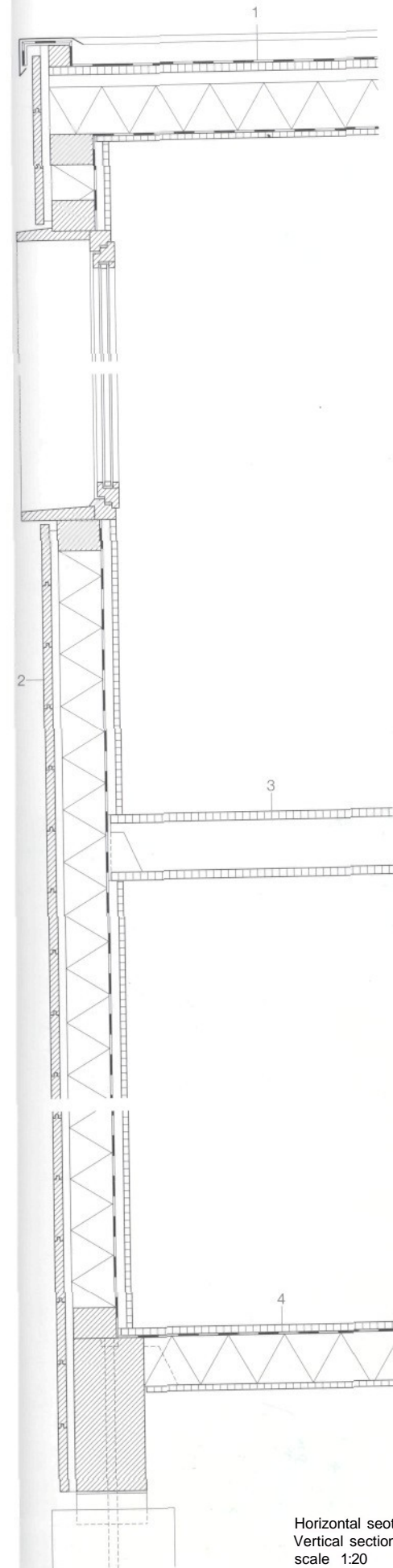
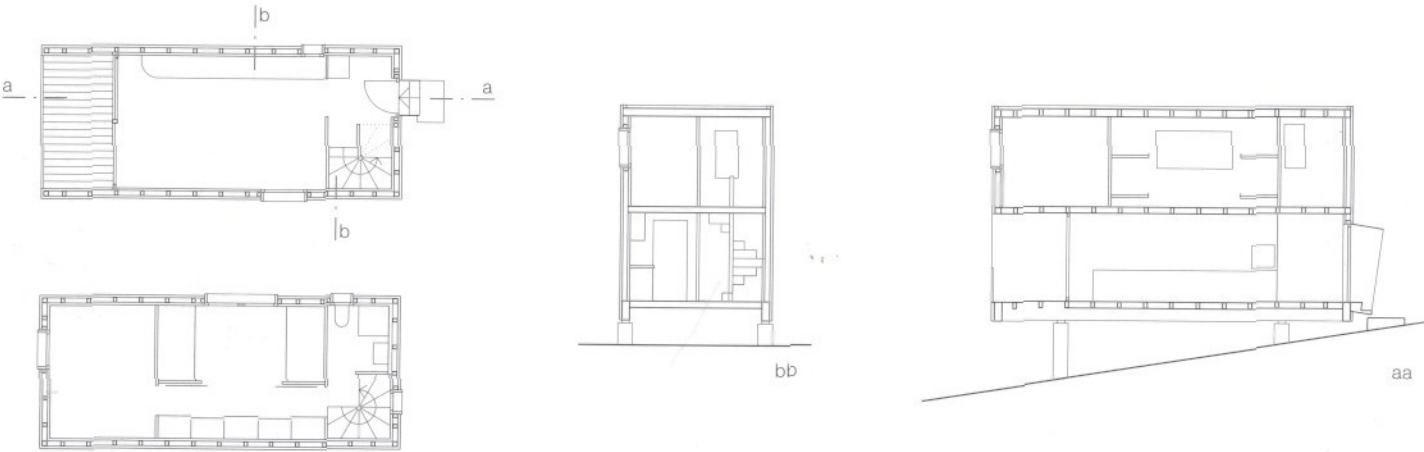

- 1 roof construction:  
plastic sheet sealing layer  
27 mm three-layer fir laminated boarding  
160 mm mineral-wool thermal insulation  
100/200 mm fir rafters  
vapour barrier  
19 mm three-layer fir laminated boarding
- 2 wall construction:  
27 mm larch tongued-and-grooved boarding  
27 mm battens  
140 mm mineral-wool thermal insulation  
vapour barrier  
27 mm battens  
19 mm three-layer fir laminated boarding
- 3 floor construction:  
27 mm three-layer fir laminated boarding  
100/160 mm fir rafters  
19 mm three-layer fir laminated boarding
- 4 floor construction:  
27 mm three-layer fir laminated boarding  
vapour barrier  
160 mm mineral-wool thermal insulation  
19 mm orientsd-stranfl board

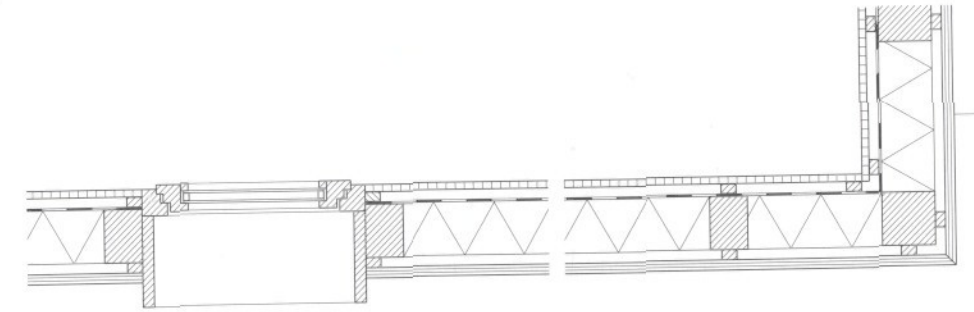

Horizontal section  
Vertical section  
scale 1:20

House near Bad Tölz

Fink + Jocher, Munich  
Dietrich Fink  
Thomas Jocher

Erected within a period of nine months with prefabricated timber elements, this two-storey, low-energy house reflects the vernacular of the local farm buildings through the use of a few simple details. The transparent areas in the north facade were kept to a minimum in order to reduce energy losses. To avoid extremes of temperature, sliding shutters with louvres set at different angles were installed for the large areas of glazing in the south, west and east faces. The timber stud walls were based on the American balloon-frame system, using full-height elements with continuous verti-

cal members. The walls are in a two-skin form of construction and are braced by the internal plywood lining. The inner leaf, in which the mechanical services are housed, bears the loads from the floor, which stops short of the vapour barrier. This ensured a simple assembly of the house and a safe, airtight construction. The wall is insulated with a total thickness of 22 cm cellulose fibre. The problem of noise transmission via the continuous vertical studs was reduced by building the inner leaf of the wall with horizontal members. The floor is in a simple, hand-nailed vertically stacked plank construction. The

advantage of this system is that it allows the use of cheaper offcut products. The floor also has great rigidity, with a structural depth comparable to that of a reinforced concrete slab. No chemical preservatives were used for the wall, floor or roof timbers. ty DETAIL 1/1998

Floor plan • Section scale 1:250

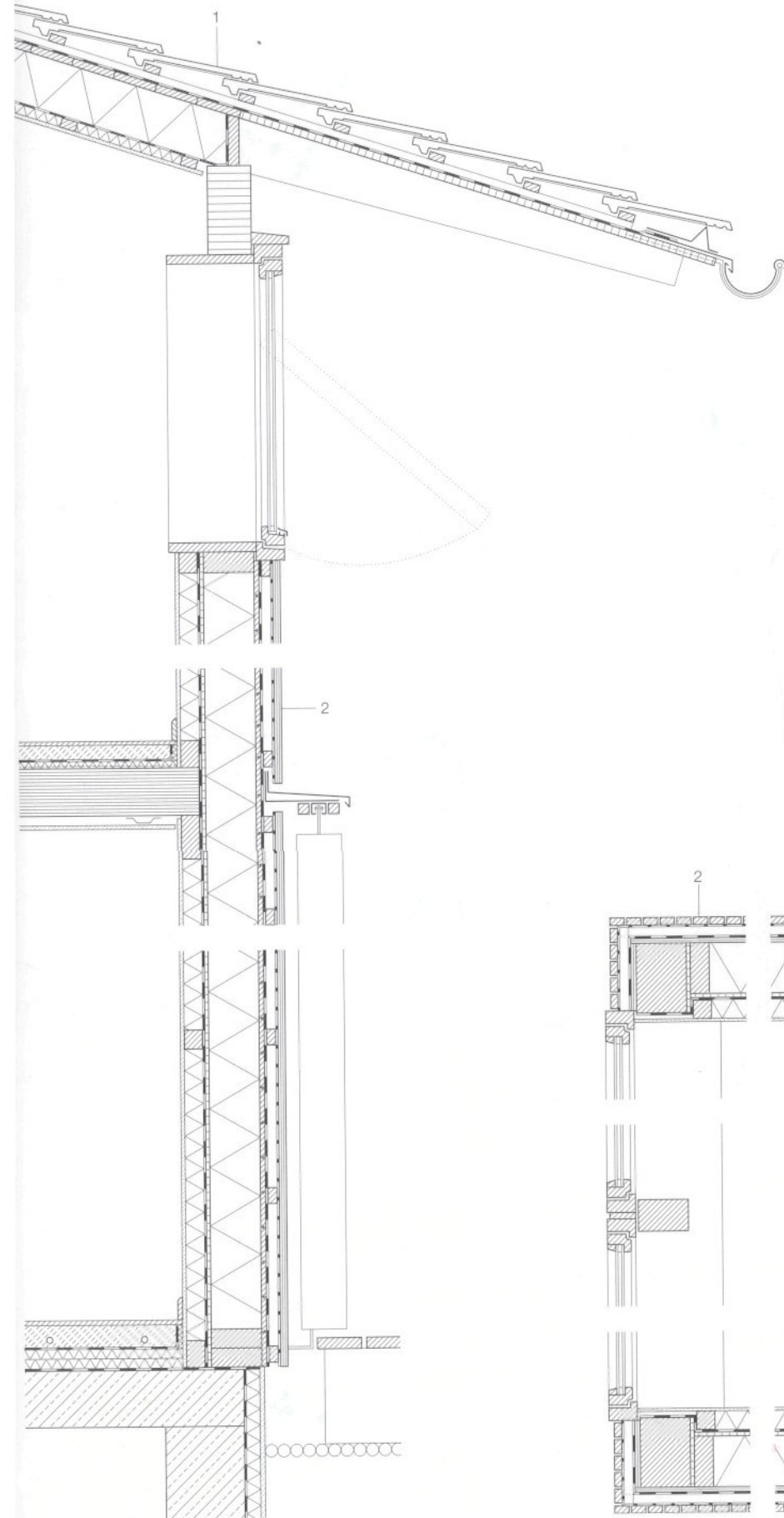
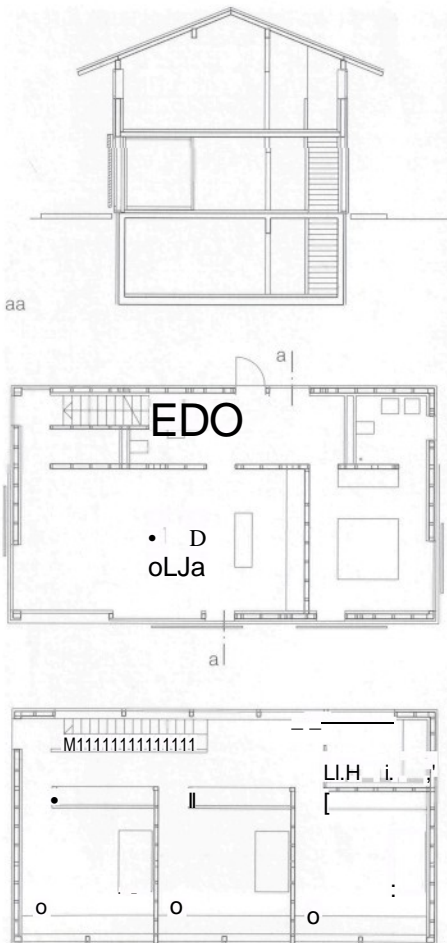

Horizontal section First floor • vertical section  
scale 1:20

- 1 roof construction: concrete roof tiles  
30/50 mm battens, 24/46 mm counter-battens  
moisture-diffusing roof sheeting  
24 mm sawn tongued-and-grooved boarding  
160 mm cellulose-fibre thermal insulation  
between 60/160 mm ratters  
aluminium foil vapour barrier  
40 mm thermal insulation  
between 40/60 mm battens  
12.5 mm plasterboard
- 2 wall construction:  
30/50 mm untreated larch strips  
insect screen, 30/50 mm battens  
moisture-diffusing wind proof building paper  
24 mm softwood tongued-and-grooved boarding  
160 mm cellulose-fibre thermal insulation  
between 60/160 mm timber studs  
12 mm plywood construction board  
polythene sheet vapour barrier  
60 mm thermal insulation between 60/60 mm  
timber battens, 12.5 mm plasterboard
- 3 larch strips splay cut on both edges;  
white glazed on edges and rear face

**Church Community Centre  
and Youth Centre in Lenting**

Andreas Meek und  
Stephan Köppel, Munich

This lightweight, largely prefabricated timber structure was erected close to the site boundary, with the hall and group rooms overlooking the garden. Access from the road is via an elevated walkway, with the entrance to the community centre at upper floor level. The large hall can be divided into smaller units by sliding partitions that disappear into recesses in the wall.

The youth centre on the lower floor has its own entrance, but is linked with the main foyer by an internal staircase. The walls are in timber stud construction braced on both faces with oriented-strand board sheets. The roof over the hall is a nailed beam structure, while the floors are in a stacked plank form of construction. The external walls and foyer walls are clad in larch boarding in a warm red tone.

CP DETAIL 1/2000

Longitudinal section  
Upper floor plan  
Ground floor plan  
scale 1:400

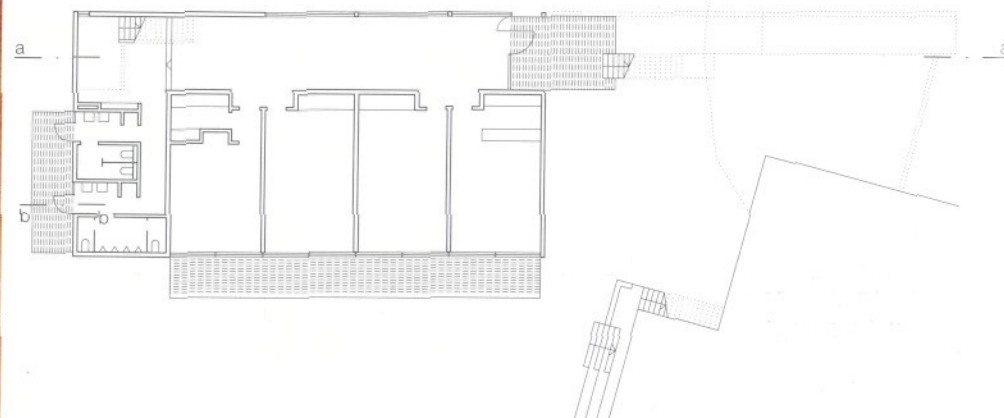
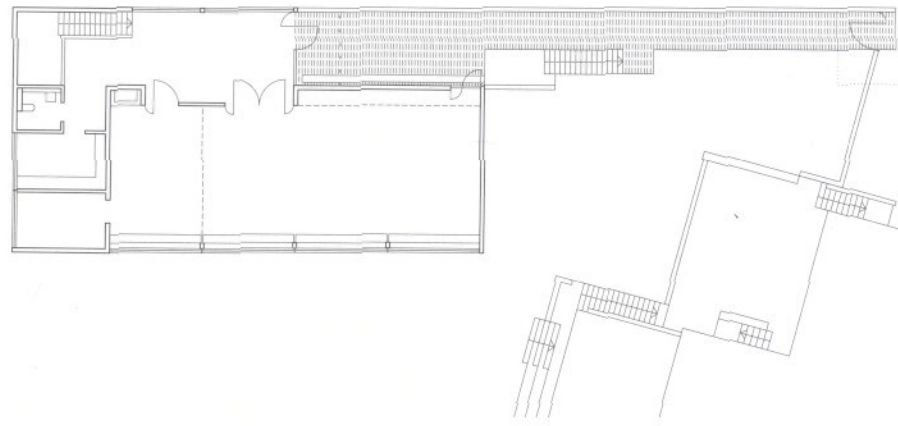
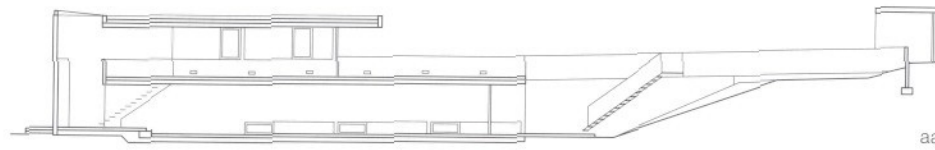
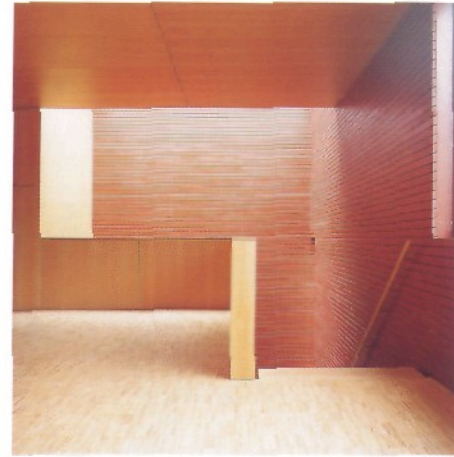

- 1 roof construction:  
2 mm plastic sealing layer  
180-280 mm insulation finished to falls  
vapour barrier  
180 mm vertically stacked plank floor  
30/50 mm battens  
18 mm beech-laminated board
- 2 wall construction:  
24/52 mm larch cladding  
40/60 mm battens  
windproof layer  
15 mm oriented-strand board  
130 mm thermal insulation  
vapour barrier  
15 mm oriented-strand board  
30/50 mm battens  
2x 12.5 mm plasterboard  
8 mm mosaic tiles

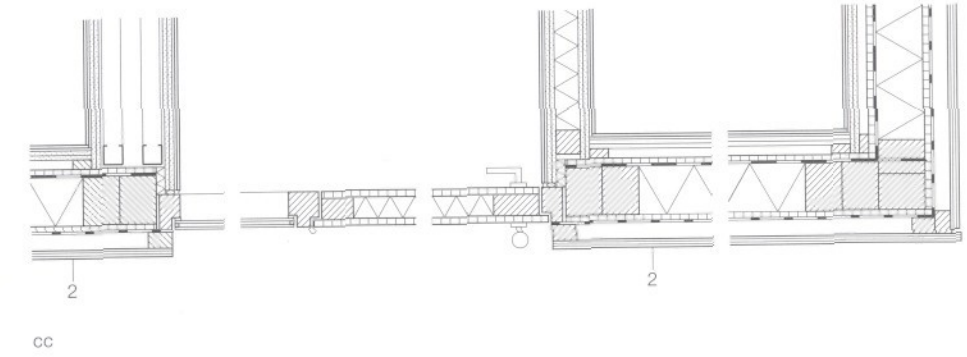

Horizontal section • vertical section scale 1:20

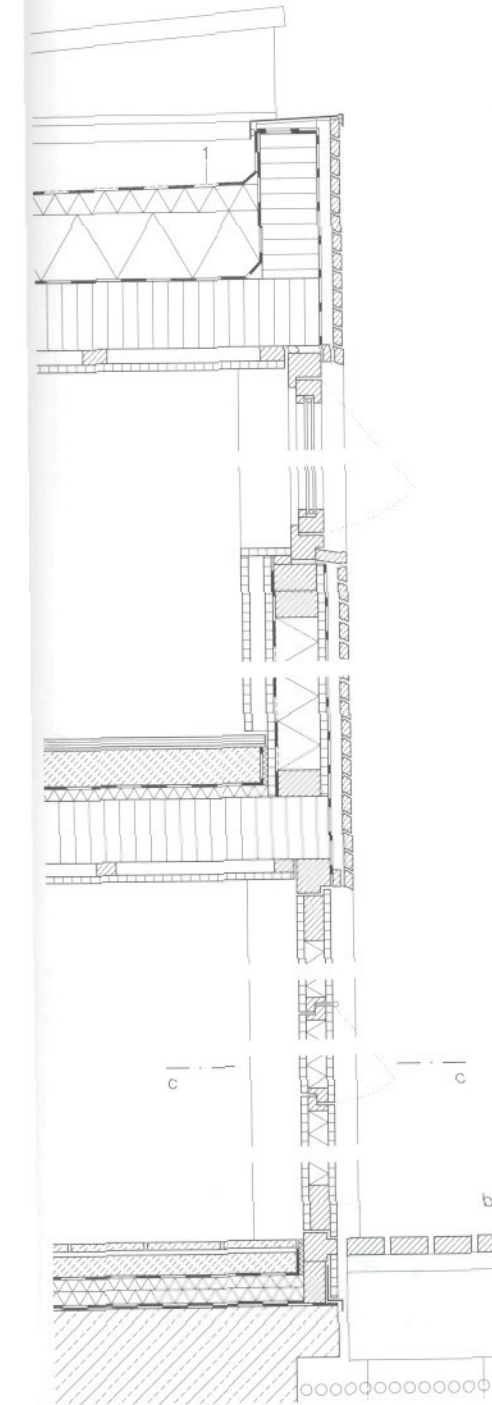

Housing Development in Trofaiach



Hubert Riess, Graz

This housing development, which occupies an entire street block, comprises two three-storey linear tracts with a protected landscaped zone between them. The strips are divided by straight-flight staircases that extend over the full width of the blocks. Each staircase provides access from the courtyard side to two dwellings on each floor. The dwellings themselves have an east-west orientation.

All external walls and party cross-walls are load-bearing and were prefabricated in storey-height units. The facade elements, extending over the full width of a dwelling, are connected by laminated timber beams and fixed to the floors. The roofs and staircases are also in a prefabricated unit construction system.

V DETAIL 4/2001

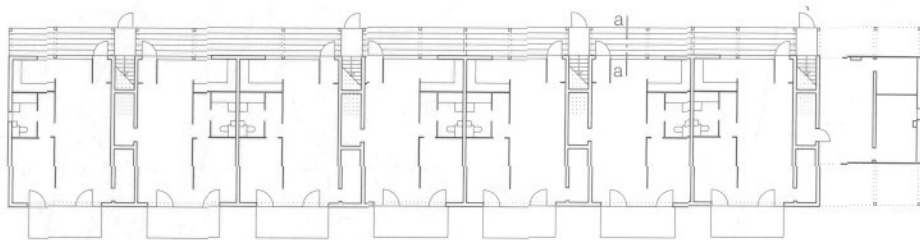
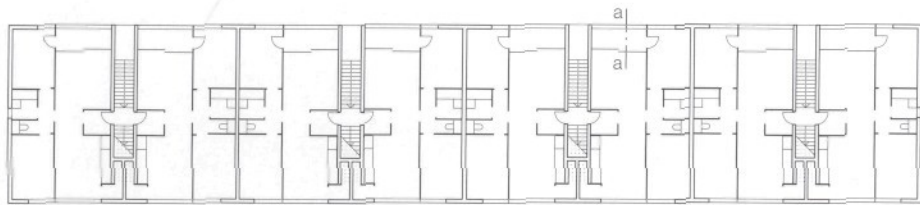

Floor plans  
scale 1:500

Horizontal section  
Vertical section  
scale 1:20

- 1 stainless-steel standing-seam roofing, leaded  
30 mm sawn timber boarding  
80/180 mm timber rafters, ventilated windproof building paper  
19 mm chipboard  
240 mm thermal insulation between  
100/240 mm softwood purlins  
polythene sheeting  
19 mm chipboard  
24 mm open-joint boarding  
15 mm gypsum fibreboard
- 2 160/480 mm laminated timber beam  
19 mm larch boarding  
30/60 mm battens  
windproof building paper  
10 mm gypsum fibreboard  
12.5 mm gypsum fibreboard  
160 mm thermal insulation between  
80/160 mm softwood posts  
polythene sheeting with welded joints  
12.5 mm gypsum fibreboard  
10 mm gypsum fibreboard

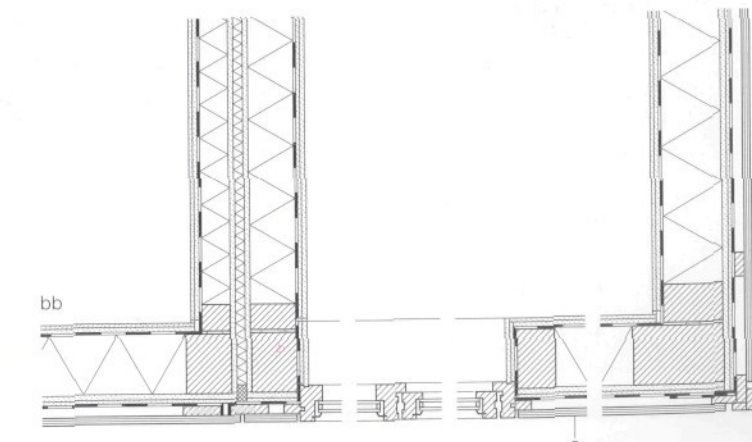
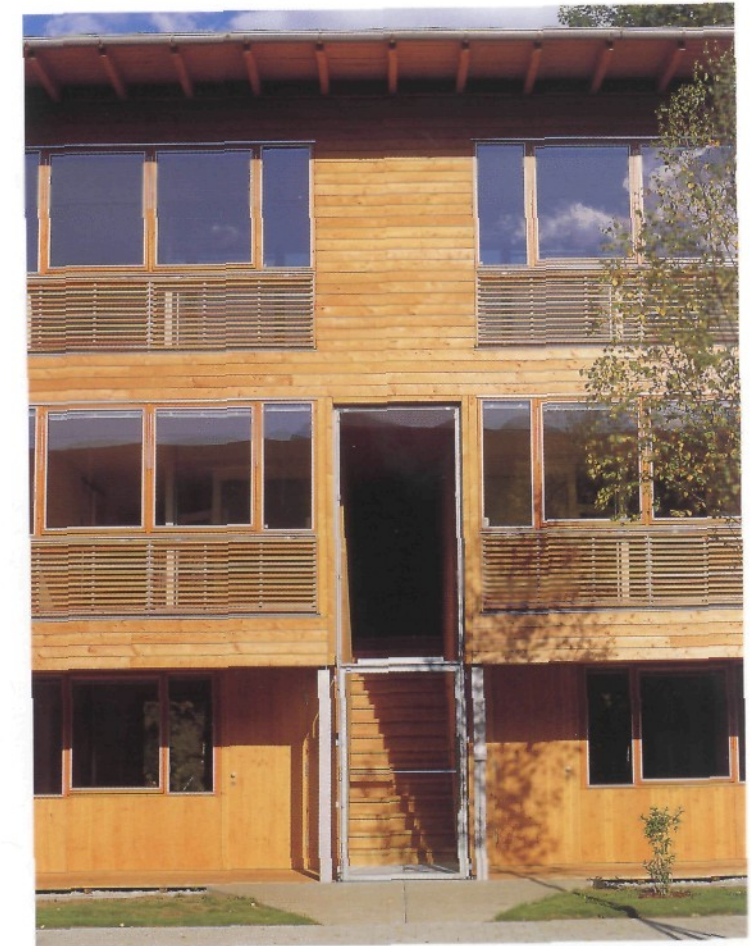

Lakeside Bathing Facilities in Zug,  
Switzerland



Alfred Krahenbuhl, Zug

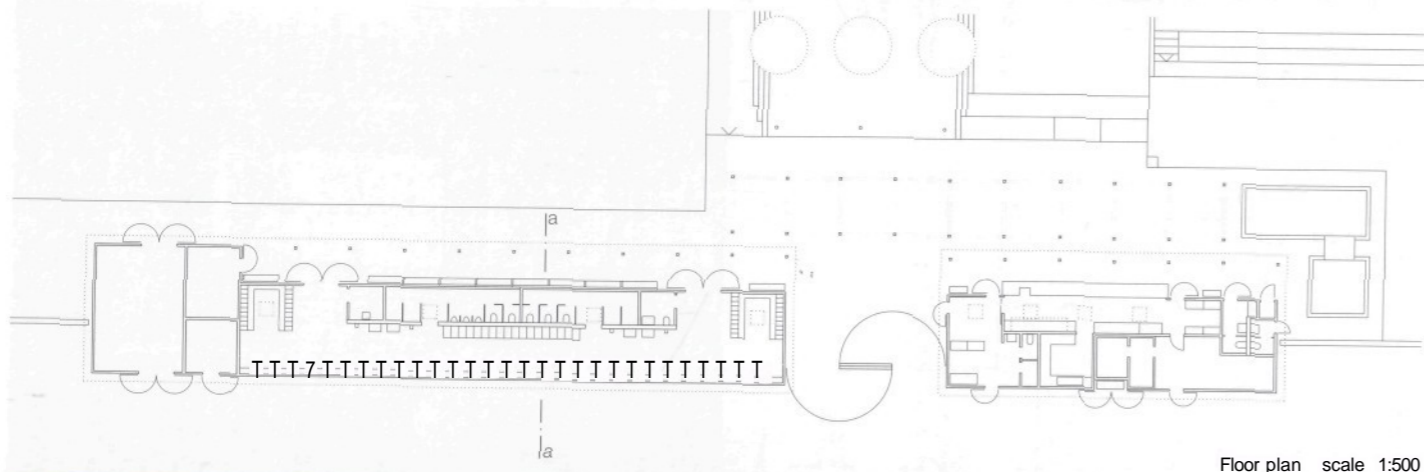

Floor plan scale 1:500

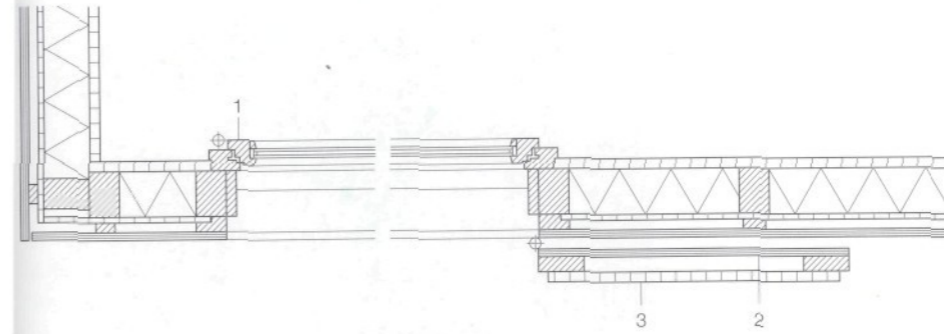

Horizontal section  
Vertical section  
scale 1:20

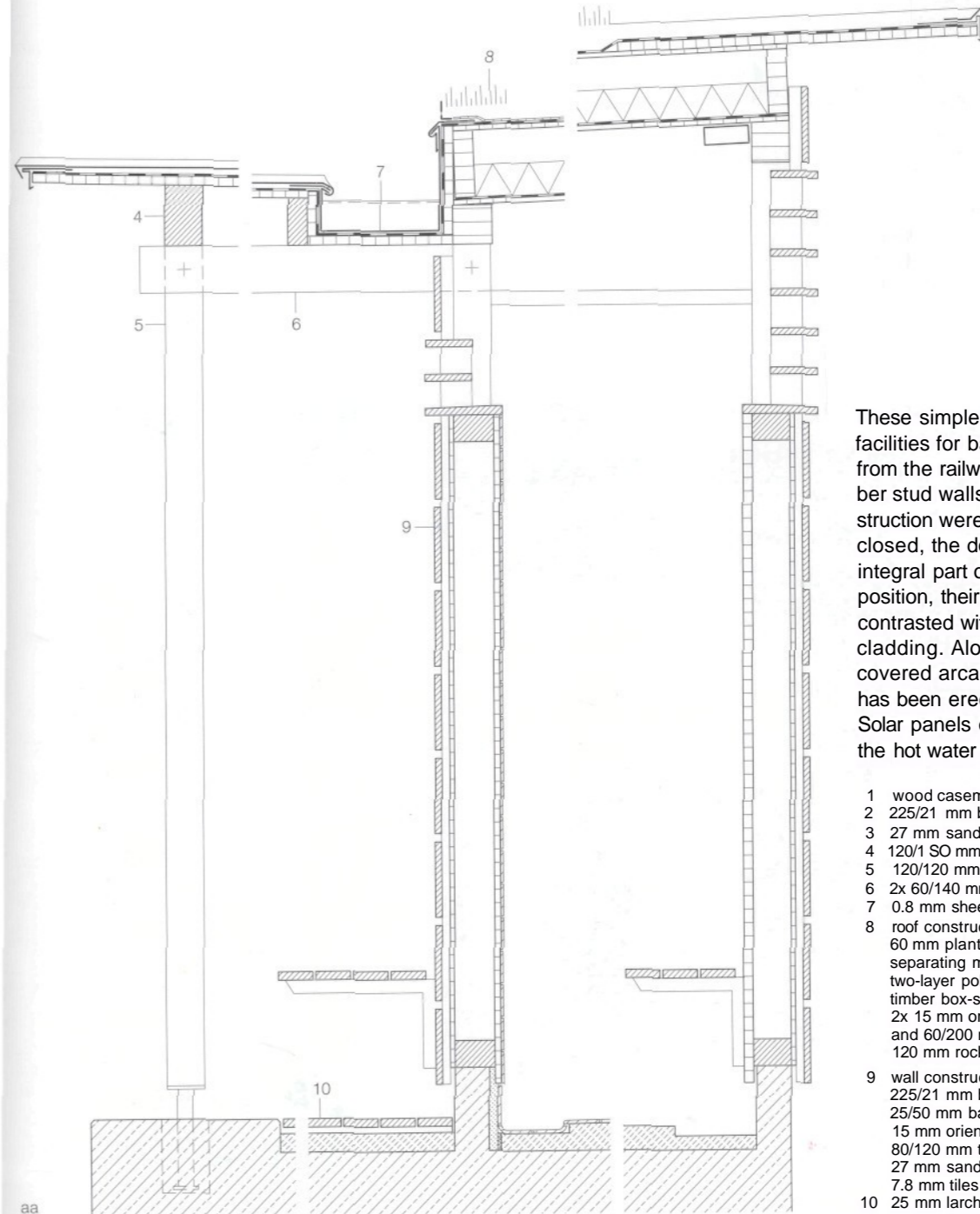

These simple timber structures, housing facilities for bathers, screen the lake shore from the railway line to the north. The timber stud walls and the box-beam roof construction were both prefabricated. When closed, the doors and shutters form an integral part of the facade. In an open position, their natural wood inner faces are contrasted with the continuous white board cladding. Along the south side is an open, covered arcade; and a shading pergola has been erected in front of the kiosk. Solar panels on the planted roof augment the hot water supply. QJ DETAIL 1/2000

- 1 wood casement with double glazing
- 2 225/21 mm boarding
- 3 27 mm sandwich slab
- 4 120/1 SO mm beam
- 5 120/120 mm post
- 6 2x 60/140 mm pairs Of beams
- 7 0.8 mm sheet copper gutter
- 8 roof construction:  
60 mm planted layer  
separating mat  
two-layer polymer-bitumen waterproof membrane  
timber box-section element:  
2x 15 mm oriented-strand board  
and 60/200 mm wood framing  
120 mm rock-wool insulation
- 9 wall construction:  
225/21 mm boarding  
25/50 mm battens  
15 mm oriented-strand board  
80/120 mm timber stud posts  
27 mm sandwich slab  
7.8 mm tiles
- 10 25 mm larch strip paving

**School Building in St Peter,  
Switzerland**



Conradin Clavuot, Chur

The new complex is well integrated into the intact local vernacular. The external walls of the school building are in a two-layer form of construction. The inner layer consists of a flexible system of 11.5 x 20 cm planed, tongued-and-grooved, but otherwise untreated horizontal beams. Shrinkage in the beams, caused by the drying out of residual moisture, together with heavy snow loads in winter, results in movement within the walls, which are up to 36 m long and 7.5 m high. To allow the wall beams to settle and still perform a load-bearing function, they are flexibly "laced" to fan-dovetailed sections screwed to a rigid system of vertical posts. The thermal insulation, casements and larch facade boarding are also fixed to the rigid posts.

CP DETAIL 1/2000



Sections  
Fourth floor plan  
Second floor plan  
scale 1:800

Section through facade of school building  
scale 1:20

- 1 roof construction: sheet copper roofing  
separating layer  
27 mm boarding; 75 mm to projecting eaves  
260/310 (160) mm beams  
waterproof membrane  
2x 60 mm rock-wool insulation  
vapour barrier  
27 mm boarding  
120/200 mm joists
- 2 wall construction:  
40 and 60 mm larch boarding  
battens/ventilated cavity  
windproof paper  
2X 80 mm rock-wool insulation  
vapour barrier  
120 mm cavity between posts  
26 mm sandwich slat,  
as bracing only in casement area  
45 mm space for service runs  
115/200 mm horizontal laced  
softwood beams

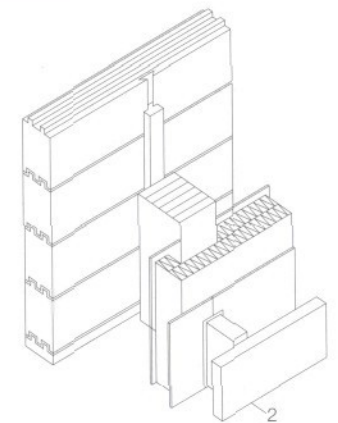
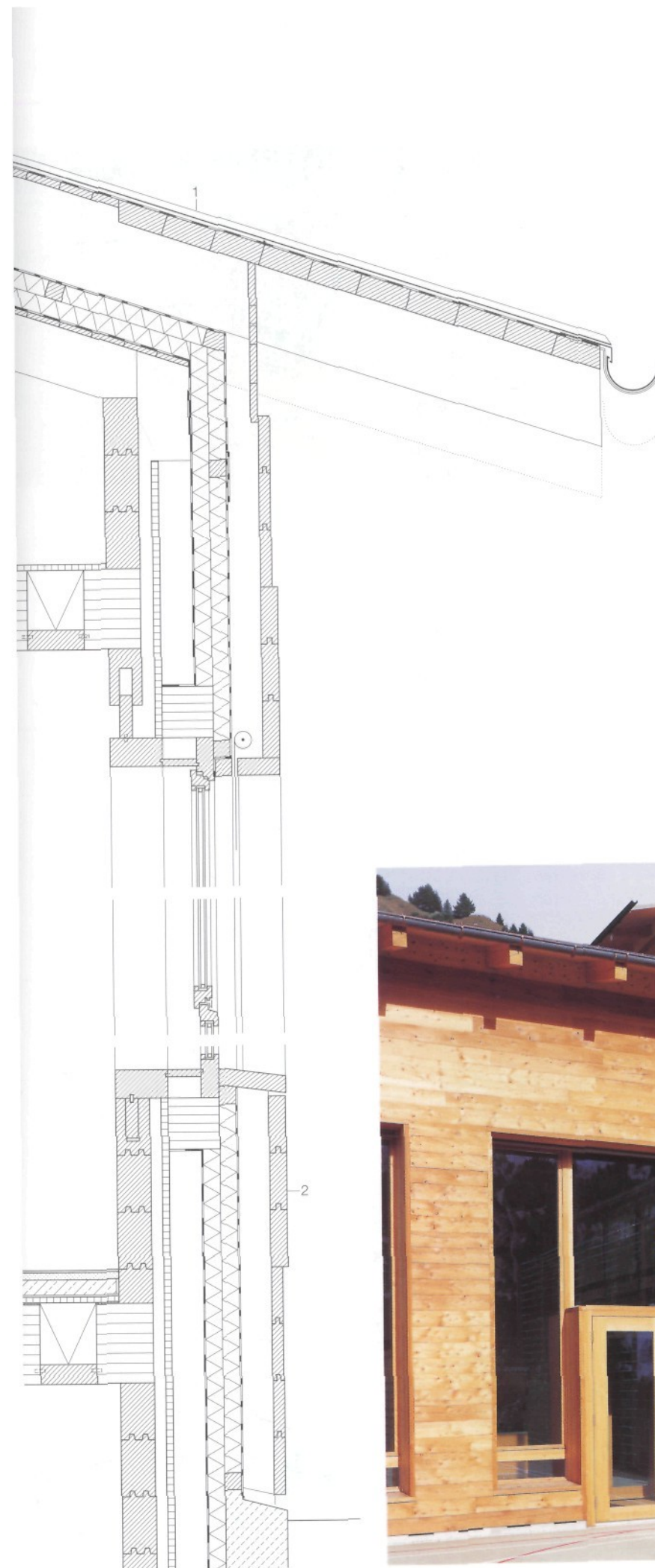

Isometric of standard wall construction



**Media Library in the Cantonal School in  
Kiisnacht**

Marie-Claude Bétrix &  
Eraldo Consolascio  
Eric Maier, Erlenbach

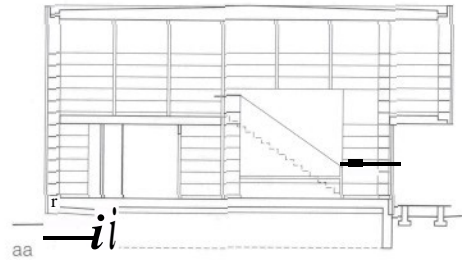

Sections • Floor plans scale 1:250

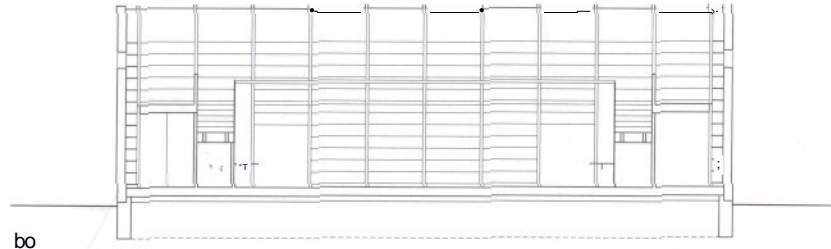

In this new building, which seeks to evoke the spatial atmosphere of classical libraries, the shelving forms part of the load-bearing structure. The closed side walls, the intermediate floor and the roof consist of prefabricated timber box elements. The sides of the shelving, in laminated timber sheeting, function as vertical columns. As tension elements, they also bear the loads from the cantilevered section of the upper floor, which is suspended from the roof. The highly insulated external walls and roof, the extremely low U-value of the glazing, and the controlled ventilation of the internal spaces coupled with a heat recovery system ensure a low energy consumption that complies with the Swiss "minergie" standard. CP DETAIL 5/2002

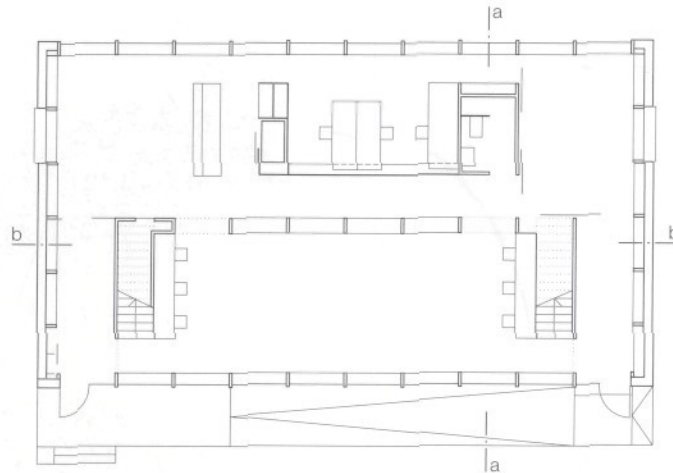

Details section scale 1:20

- 1 40 mm fine stone chippings on separating layer  
two-layer waterproof membrane with  
root-resisting layer  
27 mm laminated timber sheeting  
330-440 mm cellulose thermal insulation  
33 mm laminated limber sheeting
- 2 demountable masking sheet
- 3 100/431 mm lam. timber sheet column
- 4 33 mm lam. timber shelf
- 5 6 mm linoleum with cork backing  
27 mm lam. timber sheeting  
230 mm expanded clay filling  
27 mm lam. timber sheeting
- 6 fabric blind
- 7 low-E glazing;  $U = 0.54 \text{ W/m}^2\text{K}$
- a 10 mm screen-printed toughened safety glass
- 9 sheet-copper gutter and covering
- 10 softwood cover strip

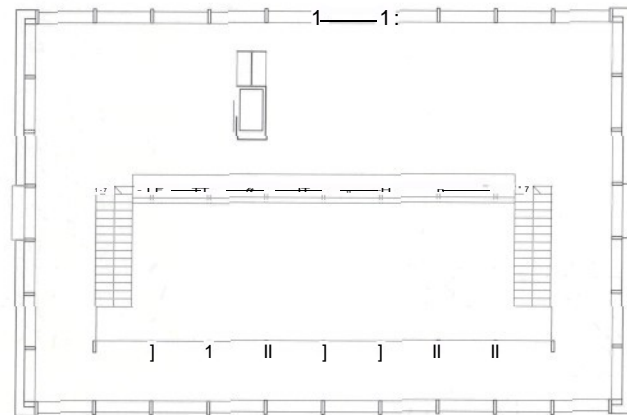

**Parquet Showrooms in Lindau**

Karl Theodor Keller, Munich

Based on a rectangular plan, this simple building replaces an earlier house of the same form. On the ground floor is a sales area and a store; on the upper floor, an office and exhibition space. The load-bearing structure consists largely of a thermally insulated timber skeleton frame. In the area of the shop, however, the outer walls and the first floor are in a solid form of construction. Externally, the building is clad with common formwork planks articulated by glass strips of the same size. This determined not only the dimensions of the external grid, but also the form of construction. A continuous hori-

zontal band of glazing - openable in part - extends along all faces of the building. It is complemented by conventional windows.

KJ DETAIL 7/1998

Standard facade details  
scale 1:10

- 1 wall construction: impregnated formwork panels with galvanized steel edge strips  
saw-tooth battens/cavity  
wmdproof sheeting  
rock-wool insulation between 100/180 mm  
posts and rails  
vapour barrier  
16 mm untreated lam. building board
- 2 double-glazing strip; opening light
- 3 stainless-steel frame
- 4 saw-tooth battens
- 5 fixed double glazing

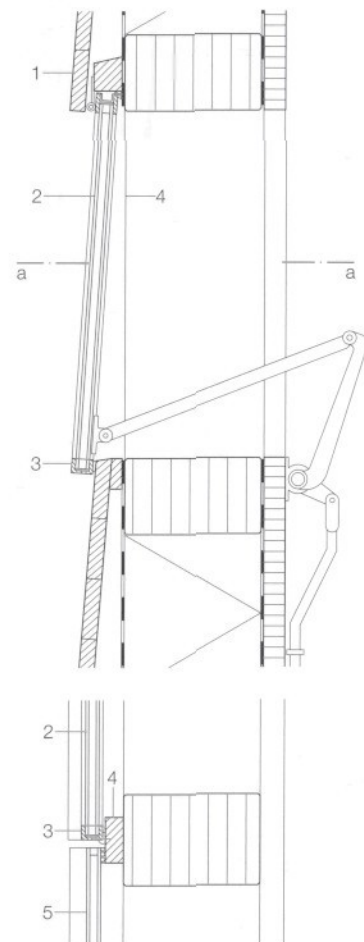

Appendix

98	Grades
99	Material classes
100	Standards
101	Literature
102	References
107	Subject index
109	Index of projects
110	Picture Credits



Grading criteria for squared timber, visually graded in accordance with DIN 4074-1

Grade characteristics	Grade S7	Grade S10	Grade S13
1. Wane	all four sides must be stripped continuously with a cutting tool	up to 1/3; in each cross-section at least 1/3 of each cross-section side must be wane free	up to 1/8; in each cross-section at least 2/3 of each cross-section side must be wane free
2. Knots	up to 3/5	up to 2/5, not exceeding 70 mm	up to 1/5, no more than 50 mm
3. Avg. width of annual rings for Douglas fir	-	up to 6 mm up to 8 mm	up to 4 mm up to 6 mm
4. Grain slope	up to 200 mm/m	up to 120 mm/m	up to 70 mm/m
5. Cracks: • Radial shakes (checks) • Lightning shakes Frost cracks Round shakes	permissible not permissible	permissible not permissible	permissible not permissible
6. Stains: • blue-stain • brown and red stripes: low nail-holding capacity  • red rot • white rot	permissible permissible for up to 3/5 of the cross section or the surface not permissible	permissible permissible for up to 2/5 of the cross-section or the surface not permissible	permissible permissible for up to 1/5 of the cross-section or the surface not permissible
7. Compression wood	permissible for up to 3/5 of the cross-section or the surface	up to 2/5 of the cross-section or permissible for the surface	permissible for up to 1/5 of the cross-section or the surface
8. Insect holes	boreholes, caused by insects attacking green wood, of up to 2 mm in diameter permissible	boreholes, caused by insects attacking green wood, of up to 2 mm in diameter permissible	boreholes, caused by insects attacking green wood, of up to 2 mm in diameter permissible
9. Misteltoe attack	not permissible	not permissible	not permissible
10. Camber, longitudinal curvature, twisting	up to 15 mm/2 m	up to 8 mm/2 m	up to 5 mm/2 m

Maximum values for the moisture of woods for load-bearing and reinforcing building elements; these values must not be exceeded during the period of use. (Table 2 DIN 68800-2)

Material class	Moisture max u	
20	15% (12 for fibreboard)	The boards must not become moist, or only to the extent that their moisture content increases over a short period and does not exceed 15 mass-% at any point, Penetrating moisture must be able to escape unhindered.
100	18 %	If surrounding air conditions permit either a higher long-term equilibrium moisture content (EMC) in the boards or a short-term increase in their moisture content provided the latter does not exceed 18 mass-% at any point and any additional penetrating moisture can escape unhindered.
100 G	21 %	If surrounding air conditions permit a higher long-term EMC or higher moisture content in boards and penetrating moisture can only escape over an extended period of time.

Required material classes (Table 3 DIN 68800-2)

Line	Material class	Area of Application
1		Cladding on the room side of walls, as well as on ceilings and roofs in residential buildings and in buildings used for comparable purposes.
1.1	20	In general:
1.2	20	Surface panelling as well as load-bearing or reinforcing panelling of ceilings below attic floors that have not been fitted out.
	100	a) ventilated ceilings
	20	b) non-ventilated ceilings
		- without an adequate insulation layer
		-with an adequate insulation layer (1/A £0.75 m <sup>2</sup> K/W)
2		Outside panelling on exterior walls
2.1	100	Ventilated cavity between exterior cladding and weatherproofing skin.
2.2	100	Weatherproofing skin, cavity insufficiently ventilated, diffusion-open, and water-draining covering over the panelling.
2.3	100	Thermal-insulating composite system directly attached to panelling.
2.4	100	Masonry facing shell, cavity insufficiently ventilated, panel covering with;
		a) water-draining layer with s <sub>0</sub> > 1 m
		b) HR-foam panels at least 30 mm thick.
3		Top panelling of roofs, load-bearing or reinforcing roof-boarding
3.1		Panelling or boarding in contact with the room air
3.1.1	20	Attached thermal -insulating layer (e.g. in residential buildings, heated halls)
3.1.2	100G	Without attached thermal -insulating layer (e.g. flat roofs on unheated halls)
3.2		Roof cross-section ventilated beneath the panelling or boarding
3.2.1	100	Pitched roof with covering
3.2.2	100G	Flat roof with moisture-proof roofing
3.3		Roof cross-section not-ventilated beneath the panelling or boarding
3.3.1	100G	Ventilated cavity above the panelling or boarding, material covered on the upper side with water-repelling foil or similar material
3.3.2	100	No vapour-barriers (e.g. foils) beneath the panelling or boarding, thermal insulation mainly above the panelling or boarding

Cases not mentioned here are to be classified in accordance with the above when determining the required material class. Classes 20 or 100, which have been determined in this way, may not- under any circumstances - be replaced by class 100 G. According to DIN 68800-5, wood-based materials serving as load-bearing and reinforcing elements must be protected against fungi in cases where moisture loads are high; this measure is expedient for wood-based materials not used as load-bearing elements.

The German Ordinance on Energy Saving (EnEV 2002), thermal insulation ordinance, the ordinance on energy-saving thermal protection in buildings.

## Standards

DIN 1052 Part 1: Structural use of timber; design and construction	specifications for building works: carpentry and timber construction work
DIN 1052 Part 2: Structural use of timber; mechanically fastened joints	DIN 18542 Sealing of outside wall joints with impregnated sealing tapes made of cellular plastics - Impregnated sealing tapes - Requirements and testing
DIN 1055 Action on structures	DIN 18560 Screeds in building construction
DIN 1101 Wood wool slabs and multi-layered slabs as insulating materials in building	DIN 68100 Tolerance system for wood working and wood processing; concepts, series of tolerances, shrinkage and swelling
DIN 4070-1 Softwood; cross-sectional dimensions and static values for sawn timber, square timber stock and roof battens	DIN68122Tongued-and-grooved chamfered boards of coniferous timber
DIN 4070-2 Coniferous timber; dimensions of cross-sections and static values, goods sawn for dimensions and specification	DIN 68123 Weatherboards made of coniferous timber
DIN 4071-1 Unplaned boards and planks made of coniferous timber; dimensions	DIN 68126-1 Profile boards with chamfer and broad root: dimensions
DIN 4072 Boards tongued and grooved, made of coniferous timber	DIN 68126-3 Profile boards with chamfer and broad root; grading for white-wood and redwood
DIN 4073-1 Planed boards and planks, made of coniferous timber; dimensions	DIN 68364 Properties of wood species: density, modulus of elasticity and strength
DIN 4074-1 Strength grading of wood; coniferous sawn timber	DIN 68365 Structural timber for carpentry; quality conditions
DIN 4102 Fire behaviour of building materials and building components	DIN 68705-2 Plywood - Part 2; Block-board and laminboard for general use
DIN 4108 Thermal protection and energy economy in buildings	DIN 68705-3 Plywood; structural plywood
DIN 4109 Sound insulation in buildings; - requirements and testing	DIN 68705-5 Plywood; structural plywood made of beech
DIN 17440 Stainless steels - technical delivery conditions for drawn wire	DIN 68755 Wood-fibre products for insulation of buildings
DIN 18161-1 Cork products as insulating building materials; insulating materials for thermal insulation	DIN 68762 Chipboard for special purposes in building construction; concepts, requirements, testing
DIN 18164-1 Cellular plastics as insulating building materials - Part 1: Insulating materials for thermal insulation	DIN 68764 Particle boards; extruded boards for the building; terms, properties, testing, supervision
DIN 18165 Fibrous insulating building materials	DIN 68765 Particle boards; decorative laminated particle boards; terms, requirements
DIN 18180 Gypsum plasterboard; types, requirements and testing	DIN 68800-1 Protection of timber used in buildings; general specifications
DIN 18182 Accessoires for use with gypsum plasterboards	DIN 68800-2 Protection of timber; preventive constructional measures in buildings
DIN 18195-1-5 Water-proofing of buildings	DIN 68800-3 Protection of timber; preventive chemical protection
DIN 18203-3 Tolerances for building; building components of timber and wood based panel products	DIN 68800-5 Protection of timber used in buildings; preventive chemical protection for wood-based materials
DIN 18334 Contract procedures for building works - Part C: General technical	

## Literature

Arbeitsgemeinschaft Holz e.V., Informationsdienst Holz, Holzbau Manual Series 1: Entwurf und Konstruktion Series 2: Tragwerksplanung Series 3: Bauphysik Series 4: Baustoffe Series 6: Ausbau und Trockenbau	GoizK.-H., HoorD., MöhlerK., Natterer J., Timber Design & Construction, 1989	Sell J., Eigenschaften und Kenngrößen von Holzarten, 1987
BairstowJ.E.N., Practical & Decorative Woodworking Joints, 1987	Graubner W., Holzverbindungen, 1986	The Woodbook, 2002
Bayerische Architektenkammer, Baustoffinformationssystem Baustoffe-Umwelt-Gesundheit, 2000	Grosser D., Die Hölzer Mitteleuropas, 1997	The Woodworker's Handbook, 1987
Bayerisches Staatsministerium des Inneren - Oberste Baubehörde - Wohnungen in Holzbauweise, Wohnmodelle Bayern Band 2, 1997	Grosser D., Pflanzliche und tierische Bau- und Werkholz-Schadlinge, 1985	Volland K., Einblicke in die Bausioffkunde, 1999
Bosshard H., Holzkunde Band 1 bis 3, 1982	Gutdeutsch G., Building in Wood - Construction and Details, 1996	The German Ordinance on Energy Saving (EnEV 2002), thermal insulation ordinance, the ordinance on energy-saving thermal protection in buildings.
Bund Deutscher Zimmermeister im Zentralverband des Deutschen Baugewerbes e.V., Technik im Zimmererhandwerk, 1997	Kordina K., Meyer-Ottens C., Holz Brandschutz Handbuch, 1994	
Bund Deutscher Zimmermeister im Zentralverband des Deutschen Baugewerbss e.V., Holzrahmenbau, 1993	Krenov J., Worker in Wood, 1981	
Bund Deutscher Zimmermeister im Zentralverband des Deutschen Baugewerbes e.V., Holzrahmenbau mehrgeschossig, 1996	Landsberg H., Pinkau S., Holzsysteme für den Hochbau, 1999	
Detail Review of Architektur, Timber Construction, 1/2000, 5/2002	LeifeB., Holzschutzmittel im Einsatz, 1992	
DIN. Beuth-Komentare Holzschutz, Baulich-Chernisch-Bekämpfend, Erläuterungen zu DIN 68800-2,-3,-4	Nakahara Y., Japanese Joinery. A handbook for joiners and carpenters, 1983	
Engel H., Tragsysteme-Structure Systems, 1967	Herzog T., Natterer J., Schweitzer R., Volz M., Winter W. Timber Construction Manual, 2003	
FinkD., JocherT., Wohnungen 3-und 4-geschossig in Holz gebaut, 199?	Odate T., Japanese Woodworking Tools: Their traditions, spirit and use, 1984	
Gerner M., Handwerkliche Holzverbindungen der Zimmerer, 1992	ScholzW., HieseW., Baustoffkenntnis 14. Auflage, 1999	
Gockel H., Konstruktiver Holzschutz, Bauen mit Holz ohne Chemie, 1998	Schriften des Deutschen Instituts für Bautechnik (DIBt), Holzschutzmittelverzeichnis, 51. Auflage, 1999	
	Schulz H., Holzbau, Wände-Decken-Dächer, 1996	
	SchunckeE., OsterH.J., Barthel R., Kiessl K., Roof Construction Manual - Pitches Roofs, 2003	
	SeikeK., The Art of Japanese Joinery,1986	





TS Teutoburger Spettholz GmbH Pivrtsheder StraBe 22 D-32758 Detmold Tel. +49/5232/981-00 Fax. +49/5232/981-999 p. 42	Verband der Deutschen Holzwerkstoffindustrie VHI e.V. Ursulum 18 D-35396 Gieten Tel. +49/641/97547-0 Fax. +49/641/97547-99 pp. 42, 46	Lolhar Zipse Korkvertrieb TullasiraBe 26 D-79341 Kenzingen Tel. +49/7644/9119-0 Fax. +49/7644/9119-34 pp. 56, 63
Thermal Ceramics Deutschland GmbH & Co. KG Borsigstraße 4-6 D-21465Reinbek Tel. +49/40/72709-100 Fax. +49/40/72709-5100 p. 65	Westag 8 Getalit AG Hellweg 15 D-33378 Rheda-Wiedenbrück Tel. +49/5242/17-2000 Fax. +49/5242/17-72000 p. 42	
Thermowoh Dammstoffe GmbH Hoheimer StraGe 1 D-97318 Kitzingen Tel. +49/9321/322-01 Fax. +49/9321/322-06 p. 61	WIKAI Solier- und Dammtechnik GmbH Bischof-Neumann-Strafie 23a D-85051 Ingolstadt Tel. +49/8450/937-0 Fax. +49/8450/1647 PD 66,68.69	
Tiüringer Dammstoffwerke GmbH Am Schlossberg 3 D-99438 Bad Berka Tel. +49/36458/37-0 Fax. +49/36458/37-198 p. 60	Wilhelmi Weike AG Dr. Hans-Wilhelmi-Weg 1 D-35633 Lahnau Tel. +49/6441/601-0 Fax. +49/6441/63439 p. 47	
TreuHanf AG Am Treptower Park 30 D-12435 Berlin Tel. +49/30/5369915-3 Fax. +49/30/5369915-4 p. 62	Holzwerka Wimmer GmbH Max-Breiherr-SiraBe 20 D-84347 Pfarrkprchen Tel. +49/8561/3005-0 Fax. +49/8561/3005-55 p. 35	
Trus Joist BehringstraDe 10 D-82152Planegg Tel. +49/89/8550-96 Fax. +49/89/8550-886 pp. 43, 44, 45	Johann Wolf GmbH 8 Co. Systembau KG Am Siactwald 20 D-94486 Osierhofen Tel. +49/9932/37-0 Fax. +49/9932/2893 p. 73	
UPM-Kymmene Wood GmbH Postfach 105728 D-20039 Hamburg Tel. +49/40/248446-0 Fax. +49/40/248446-10 p. 42	Dr. Wolmann GmbH Dr.-Wolmann-StraBe 31-33 D-76547 Sinzheim Tel. +49/7221/800-0 Fax. +49/7221/800-290 p. 77	
Oberwachungsgemeinschaft Konstruktionsvollholz e. V. Postfach 6128 D-65051 Wiesbaden Tel. +49/611/97706-0 Fax. +49/611/97706-22 p. 35	Adolf Würth GmbH S Co. KG Reinhold-Würth-StralBe 12-17 D-74653 Künzelsau-Gaisbach Tel. +49/7940/15-0 Fax. +49/7940/15-1000 p. 72	
Vedag AG Flinschstra3e 10-16 D-60388 Frankfurt/Main Tel. +49/69/4084-0 Fax. +49/69/4258-24 pp. 66, 67	Ulrioh Zeh GmbH 8 Co. KG Holz- und Leimbau Obersteig 2 D-88167 Maierhofen/Allgau Tel. +49/8383/92051-0 Fax. +49/8383/92051-99 p. 36	

Subject Index

airborne-sound insulation	15,27	cover strips	30	floor structure	15, 19,27
airtight	14, 18	cross-rafters	28,29	foundations	24,25
anchors	70, 71,75	cross-band veneer	22,67	frost blanket gravel	22
anchor bolts	22	damp-proofing	22,67	furniture construction	40,47
anchor nails	73	wood from deciduous trees	34	fungi	76
angle connectors	74	diaphragm action	26	gable area	17
angle sealed with tape	31	dimensional tolerances	13	gable wall	17
animal pests	76	draught-proofing	12, 14, 16,	GEKA dowels	70
backfill insulation	31		17, 18,19,27	glass fibre	67
beam hangers	74	drainage	28	glaze	13
beam supports	75	dry rot	76	glued laminated timber	26, 28, 31, 36
bitumen sheeting	67	dry screed board	15,27,52	glued laminated beams	26, 28,31, 37
biluminated wood fibres	55	dry wall screws	72	glulam pillar support	75
bituminated fibreboards	55	doorframe	15,27	grading	34
blockboard and laminated board	40	door reveal	15	granulates	56
blower door test	66	dowel	22,25,70	grey	13
boards/planks	38	"dry" construction method	24	groove nails	73
board materials	23	dry screed	15, 24,27,52	gutter bracket	16
bolt	71	eaves flashing	28	gypsum baseboard	52
building boards	51-53	edge beam	17	gypsum fibreboard	18, 23,24,53
Bulldog dowels	70	edge of ceiling	14	gypsum plasterboard	52
butt joint	18	edge rafter	17	hardwood	34, 40, 70
canvas bands	74	energy saving	14,66	hazard classes	22,76
cavity flocks	62	equalising unevenness	25	heavy-duty bolt	12,13
cavity insulation	63	expandable polystyrene	57	hemp	62
cavity fill	65	expanded mica	23	heat loss	12
cellulose	64	expansion joint	19,31	high-expansion cement mortar	12,22,25
cellulose flakes	23,64	exterior boarding	17	horizontal rails	13
cemented chipboard	24	exterior corner	18	HR-foam	57,59
centre distance	23	exterior lining	12	humid rooms	23
ceramic tiles	18	exteriorwall	12, 14, 16, 17,	humidity	53,57
chemical wood preservative	12, 16,42,		18,22,24,31,66	impact-sound insulation	15,24,54,
	76,77	exterior wall elements	23		57,60,67
chimney linings	65	external cladding	38	in situ foam	59
chipboard	24, 46, 49	extruded particle boards	49	insects	76
coat of paint	13	extruded polystyrene	58	insulating board	12,56
coconut	13,63	face veneer	40	insulating materials	14, 19, 54-65
coconut fibre	13, 23, 63	facing panels	30	insulation value	23
coconut insulating mats	63	facing shell	31, 63	integral connectors	75
coconut rolled felting	63	fascia	28	interior lining	13
coconut wall panels	63	fibrated concrete slab	24	interior wall	15,25,27
coarse gravel strips	12	fibreboard	29,47	interior wall elements	23
composite elements	54	fibre cement board	12,22,51	joint sealing tape	14,78
composite construction	37	fibre-reinforced cement board	50	joints and fasteners	38, 70-75
composite board	53	fibrous insulating material	12	joists	14-16
composite materials	60	fire resistance	31	joist hangers	14
coniferous wood	34,50	fire resistance class	19	laminated construction board	42
connecting plates	43	fire protection plasterboard	52	laminated strand lumber	45
continuous footing	25	five-ply panel	41	lintel beam	15
converted building timber	34,35	flakes	12	load-bearing lathing	38
core insulation	60,65	flat connector	74	loose fill	15
core plywood	40	flat-pressed boards	48	machine nails	73
core-stripe blockboard	40	flat roofs	57,65	manufactured wood products	40-50
cork	56	flat steel anchors	70	manufacturers	104-108
cork strip	15	flax	62	matched fibreboards	39
corner	31	floating foundation	22	material class	41,44-48
corner design	31	floorboards	15	mineral wool/fibre	19,26,60
corrosion stains	18	floor covering	50	moisture	12,25
corrugated sheet roofing	28	floor construction	24	multi-ply boards	47
cotton wool	61	flooring	15	nails	18,73
counter battens	29	floor beneath roof void	16,17	nail plates	73



**Picture credits**

p. 7:  
Kazunori Hiruta, Tokyo  
pp. 34-36, 40, 42-48, 50, 52-55:  
ARGE Holz, Düsseldorf  
p. 37:  
Kaufmann Massivholz GmbH, Oberstadion  
pp. 38, 41, 51, 62, 63:  
Friedemann Zeitler, Penzberg  
p. 39:  
Michael Weinig AG  
p. 49:  
Sauerländer Spanplatten GmbH & Co. KG  
pp. 56-61, 64, 65:  
Frank Kaltenbach, Munich  
pp. 79, 86, 87:  
Michael Heinrich, Munich  
p. 81:  
Oliver Schuster, Stuttgart  
pp. 82, 83:  
Friedrich Busam/Architekturphoto,  
Düsseldorf  
pp. 84, 85:  
Thomas Jocher, Munich  
pp. 88, 89:  
Damir Fabijanac, Zagreb  
pp. 90, 91:  
Guido Baselgia, Baar  
pp. 92, 93:  
Ralph Feiner, Malans  
p. 94:  
Thomas Jantscher, Colombier  
p. 95:  
Jan Schabert, Munich  
p. 96 top;  
Johanna Reichel-Vossen, Munich  
p. 96 bottom:  
Karl Theodor Keller, Munich

Photos without credits are from the architects' own archives or those of DETAIL Review of Architecture. Despite intense efforts we are unable to identify the copyright holders of certain photos and illustrations. The rights remain unaffected, however, and we request the copyright holders to contact us.